

Device handbook

APLUS-TFT

Operating Instructions *APLUS* with TFT display
173 013-01 06/2014



Camille Bauer Metrawatt AG
Aargauerstrasse 7
CH-5610 Wohlen / Switzerland
Phone: +41 56 618 21 11
Telefax: +41 56 618 35 35
e-Mail: info@cbmag.com
<http://www.camillebauer.com>

 **CAMILLE BAUER**
Rely on us.

Legal information

Warning notices

In this document warning notices are used, which you have to observe to ensure personal safety and to prevent damage to property. Depending on the degree of danger the following symbols are used:



If the warning notice is not followed death or severe personal injury **will** result.



If the warning notice is not followed damage to property or severe personal injury **may** result.



If the warning notice is not followed the device **may** be damaged or **may** not fulfill the expected functionality.

Qualified personnel

The product described in this document may be handled by personnel only, which is qualified for the respective task. Qualified personnel have the training and experience to identify risks and potential hazards when working with the product. Qualified personnel are also able to understand and follow the given safety and warning notices.

Intended use

The product described in this document may be used only for the application specified. The maximum electrical supply data and ambient conditions specified in the technical data section must be adhered. For the perfect and safe operation of the device proper transport and storage as well as professional assembly, installation, handling and maintenance are required.

Disclaimer of liability

The content of this document has been reviewed to ensure correctness. Nevertheless it may contain errors or inconsistencies and we cannot guarantee completeness and correctness. This is especially true for different language versions of this document. This document is regularly reviewed and updated. Necessary corrections will be included in subsequent version and are available via our webpage <http://www.camillebauer.com>.

Feedback

If you detect errors in this document or if there is necessary information missing, please inform us via e-mail to: customer-support@camillebauer.com

Contents

| | |
|--|-----------|
| 1. Introduction | 5 |
| 1.1 Purpose of this document..... | 5 |
| 1.2 Scope of supply..... | 5 |
| 1.3 Further documents | 5 |
| 2. Security notes..... | 6 |
| 3. Device overview..... | 6 |
| 3.1 Brief description..... | 6 |
| 3.2 Possible modes of operation | 7 |
| 3.3 Monitoring and alarming | 8 |
| 3.3.1 Alarming concept | 8 |
| 3.3.2 Logic components..... | 10 |
| 3.3.3 Limit values | 11 |
| 3.3.4 Sequence of evaluation | 12 |
| 3.4 Free Modbus image | 13 |
| 4. Mechanical mounting..... | 14 |
| 4.1 Panel cutout | 14 |
| 4.2 Mounting of the device | 14 |
| 4.3 Demounting of the device..... | 14 |
| 5. Electrical connections | 15 |
| 5.1 General safety notes | 15 |
| 5.2 Electrical connections of the I/Os | 16 |
| 5.3 Possible cross sections and tightening torques | 16 |
| 5.4 Inputs | 17 |
| 5.5 Rogowski current inputs | 21 |
| 5.6 Power supply..... | 22 |
| 5.7 Relays | 22 |
| 5.8 Digital inputs and outputs | 23 |
| 5.9 Analog outputs | 25 |
| 5.10 Modbus interface RS485 X4 and / or X8 | 25 |
| 5.11 Profibus DP interface..... | 26 |
| 6. Commissioning..... | 27 |
| 6.1 Software installation CB-Manager | 27 |
| 6.2 Parametrization of the device functionality..... | 28 |
| 6.3 Installation check..... | 29 |
| 6.4 Installation of Ethernet devices | 30 |
| 6.4.1 Connection | 30 |
| 6.4.2 Network installation using the CB-Manager software | 31 |
| 6.4.3 Network installation by means of local programming | 32 |
| 6.4.4 Time synchronization via NTP-protocol | 33 |
| 6.4.5 TCP ports for data transmission | 33 |
| 6.5 Installation of Profibus DP devices | 34 |
| 6.6 Protection against device data changing | 35 |
| 7. Operating the device | 36 |
| 7.1 Operating elements | 36 |
| 7.2 Symbols used for display..... | 37 |
| 7.3 Display modes..... | 38 |
| 7.4 Alarm handling | 39 |
| 7.4.1 Alarm state display on the device | 39 |

| | |
|--|-----------|
| 7.4.2 Alarm text indication on the display | 39 |
| 7.4.3 Reset of alarms | 39 |
| 7.5 Resetting measurements | 40 |
| 7.6 Configuration | 41 |
| 7.7 Data logger | 42 |
| 7.7.1 Activation of data logger recording | 42 |
| 7.7.2 SD card | 42 |
| 7.7.3 Access to logger data | 43 |
| 7.7.4 Logger data analysis | 43 |
| 8. Service, maintenance and disposal | 44 |
| 8.1 Protection of data integrity | 44 |
| 8.2 Calibration and new adjustment | 44 |
| 8.3 Cleaning | 44 |
| 8.4 Battery | 44 |
| 8.5 Disposal | 44 |
| 9. Technical data | 45 |
| 10. Dimensional drawings | 50 |
| Annex | 51 |
| A Description of measured quantities | 51 |
| A1 Basic measurements | 51 |
| A2 Harmonic analysis | 54 |
| A3 System imbalance | 55 |
| A4 Reactive power | 56 |
| A5 Mean values and trend | 58 |
| A6 Meters | 59 |
| B Display matrices in DEFAULT mode | 60 |
| B0 Used abbreviations for the measurements | 60 |
| B1 Display matrix single phase system | 63 |
| B2 Display matrix Split-phase (two-phase) systems | 63 |
| B3 Display matrix 3-wire system, balanced load | 64 |
| B4 Display matrix 3-wire systems, unbalanced load | 64 |
| B5 Display matrix 3-wire systems, unbalanced load, Aron | 65 |
| B6 Display matrix 4-wire system, balanced load | 65 |
| B7 Display matrix 4-wire systems, unbalanced load | 66 |
| B8 Display matrix 4-wire system, unbalanced load, Open-Y | 66 |
| C Declaration of conformity | 67 |
| C1 CE conformity | 67 |
| C2 FCC statement | 68 |
| INDEX | 69 |

1. Introduction

1.1 Purpose of this document

This document describes the universal measurement device for heavy-current quantities *APLUS*. It is intended to be used by:

- Installation personnel and commissioning engineers
- Service and maintenance personnel
- Planners

Scope

This handbook is valid for all hardware versions of the *APLUS* with TFT display. Some of the functions described in this document are available only, if the necessary optional components are included in the device.

Required knowledge

A general knowledge in the field of electrical engineering is required. For assembly and installation of the device knowledge of applicable national safety regulations and installation standard is required.

1.2 Scope of supply



- Measurement device *APLUS*
- Safety instructions (multiple languages)
- Software and documentation CD
- Connection set basic unit: Plug-in terminals and mounting clamps
- Optional: Connection set I/O extension: Plug-in terminals

1.3 Further documents

On the CD supplied with the device the following documents about the *APLUS* are provided:

- Safety instructions *APLUS*
- Data sheet *APLUS*
- Modbus basics: General description of the communication protocol
- Modbus interface *APLUS*: Register description of Modbus/RTU communication via RS-485
- Modbus/TCP interface *APLUS*: Register description of Modbus/TCP communication via Ethernet

2. Security notes

| | | |
|---|---|--|
|  |  | Device may only be disposed in a professional manner ! |
|---|---|--|

The installation and commissioning should only be carried out by trained personnel.

Check the following points before commissioning:

- that the maximum values for all the connections are not exceeded, see "Technical data" section,
- that the connection wires are not damaged, and that they are not live during wiring,
- that the power flow direction and the phase rotation are correct.

The instrument must be taken out of service if safe operation is no longer possible (e.g. visible damage). In this case, all the connections must be switched off. The instrument must be returned to the factory or to an authorized service dealer.

It is forbidden to open the housing and to make modifications to the instrument. The instrument is not equipped with an integrated circuit breaker. During installation check that a labeled switch is installed and that it can easily be reached by the operators.

Unauthorized repair or alteration of the unit invalidates the warranty.

3. Device overview

3.1 Brief description

The *APLUS* is a comprehensive instrument for the universal measurement, monitoring and power quality analysis in power systems. The device can be adapted fast and easily to the measurement task by means of the supplied CB-Manager software. The universal measurement system of the device may be used directly for any power system, from single phase up to 4-wire unbalanced networks, without hardware modifications. Independent of measurement task and outer influences always the same high performance is achieved.

Using additional, optional components the opportunities of the *APLUS* may be extended. You may choose from I/O extensions, communication interfaces, Rogowski current inputs or data logger. The nameplate on the device gives further details about the present version.

3.2 Possible modes of operation

The *APLUS* can cover a wide range of possible input ranges without any hardware variance. The adaption to the input signal is performed by means of variable amplifying levels for current and voltage inputs. Depending on the application it makes sense to fix these levels by means of the configuration or to let them stay variable to achieve a maximum accuracy during measurement. The differentiation, if the amplifying remains constant or is adapted to the present value, is done during the definition of the input configuration by means of the parameter "auto-scaling".

The disadvantage of auto-scaling is that when an amplifying level needs to be changed, a settling time of at least one cycle of the power frequency must be allowed until the signals have stabilized again. During this short time the measurement results remain frozen.

Continuous measurement

An absolute uninterrupted measurement of all quantities assumes that auto-scaling is deactivated for both voltage and current inputs.

Metering

The uncertainty of the active energy meters of the *APLUS* is given with class 0.5S. To fulfill the high requirements of the underlying meter standard EN 62053-22 also small currents have to be measured very accurate. To do so, auto-scaling must be activated for current inputs. For metering applications the system voltage is assumed to be quite constant, nominal value acc. standard, wherefore auto-scaling for voltages is not required. The subsequent example shows an appropriate configuration, which also conforms to the factory setting of the device.

The screenshot displays the configuration interface for the APLUS device. It is divided into several sections:

- System:** A dropdown menu is set to "4-wire system, asymmetrical". Below it, the checkbox "right-hand rotation" is checked.
- Voltage Input:** The "L - L" section has a "max." value of 480.00 V. The "prim." (primary) side is set to 400.00 V, and the "sec." (secondary) side is set to 480.00 V.
- Current Input:** The "max." value is 6.00 A. The "prim." side is set to 5.00 A, and the "sec." side is set to 6.00 A.
- Overriding and Auto-scaling:** A table at the bottom shows the following settings:

| | Overriding | Auto-scaling |
|---------|------------|-------------------------------------|
| voltage | 20.00 % | <input type="checkbox"/> |
| current | 20.00 % | <input checked="" type="checkbox"/> |

Dynamic monitoring of limit values

An important criterion when monitoring the quality of the supply voltage is the possibility to detect short sags of the system voltage. To be able to follow the progress of the voltage auto-scaling of the voltage inputs should be deactivated. Thereby you have to consider that a possible swell of the voltage may be detected only up to the configured overriding (20% of rated voltage in the above example), because the switching of the measurement range is locked in both directions.

This applies analogously to all quantities of the system, whose progress should be monitored. For power quantities the voltage amplification as well as the current amplification is influenced. However, which basic quantities may vary how much can differ from application to application.

3.3 Monitoring and alarming

The logic module integrated in the *APLUS* is a powerful feature to monitor critical situations without delay on device side. By implementing this local intelligence a safe monitoring can be realized which is independent of the readiness of the control system.

3.3.1 Alarming concept

How alarms are handled is decided during the configuration of the device. For that in the logic module you can define if alarm states will be displayed on the TFT display and how resp. when a possibly activated action, such as the switching of a relay, will be reset. These configuration parameters are highlighted in yellow in the following chart.

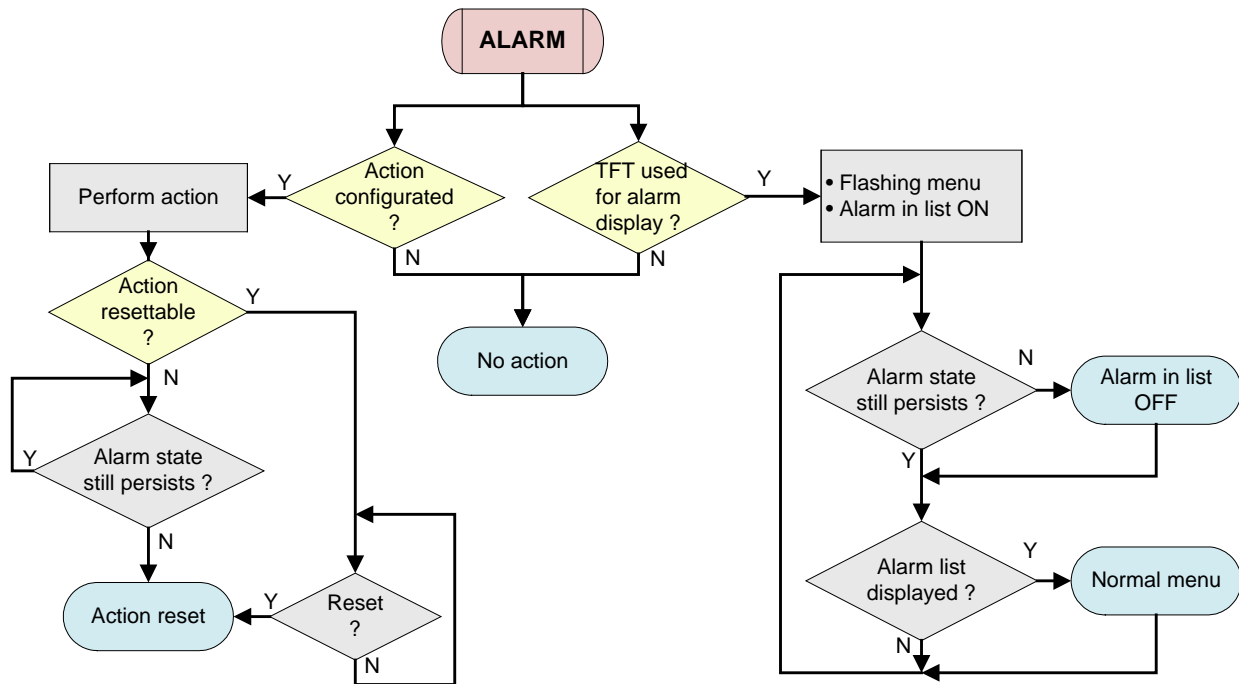

► Alarm reset: This procedure affects the states of the follow-up actions

If an alarm state occurs a follow-up action (e.g. the switching of a relay) can be triggered. This follow-up action is normally reset as soon as the alarm condition no longer exists. But the alarm handling may be configured as well in a way that only by means of an alarm reset the subsequent operation is withdrawn. This way an alarm remains stored until a reset is performed, even if the alarm situation no longer exists. Possible sources for an alarm reset are the display, a digital input, another logical state of the logic module or a command via the bus interface.

On the next page some signal flow examples are shown.

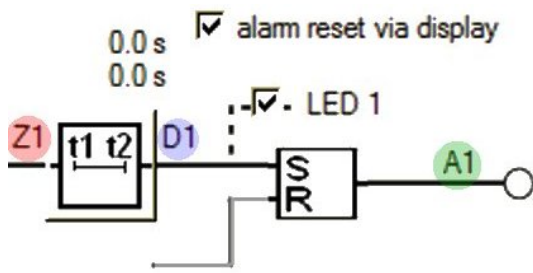

- Z:** Logic output determined from all involved logic inputs
- D:** Corresponds to signal Z, delayed by the switch-in resp. dropout delay
- A:** Output signal of the logic function
- S:** State of the subsequent operation (e.g. of a relay), corresponds normally to A, but may be inverted (subsequent operation: relay OFF)

1) Alarm reset inactive, switch-in and dropout delay 3s, follow-up action not inverted

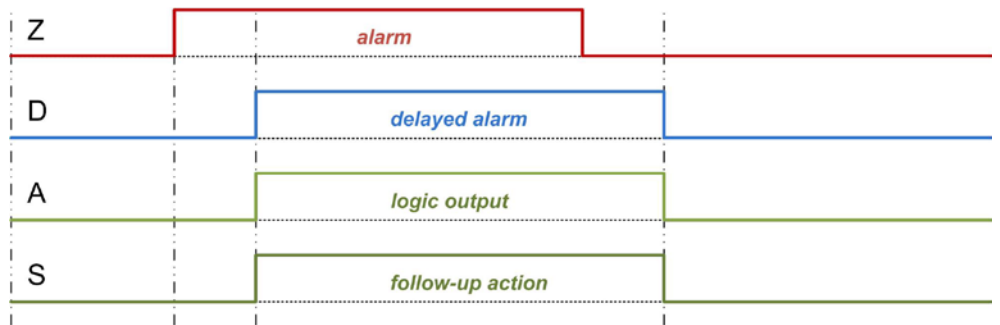

2) Alarm reset active, switch-in and dropout delay 0s, follow-up action inverted

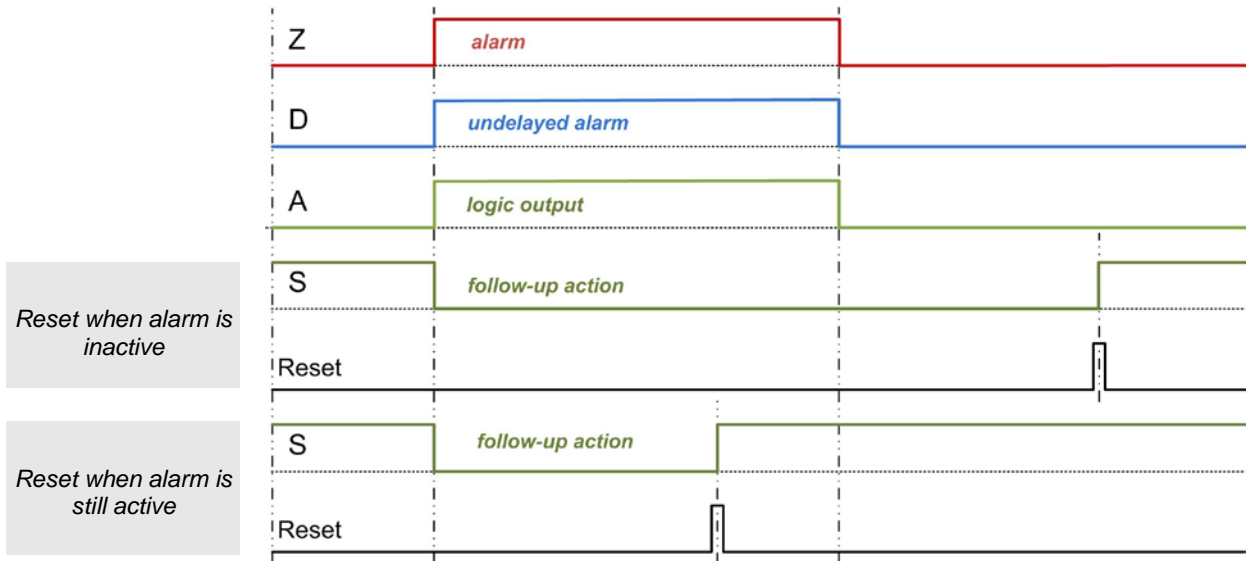

3.3.2 Logic components

The logic outputs are calculated via a two level logical combination of states, which are present at the inputs. Usable components are AND, OR and XOR gates as well as their inversions NAND, NOR and XNOR.

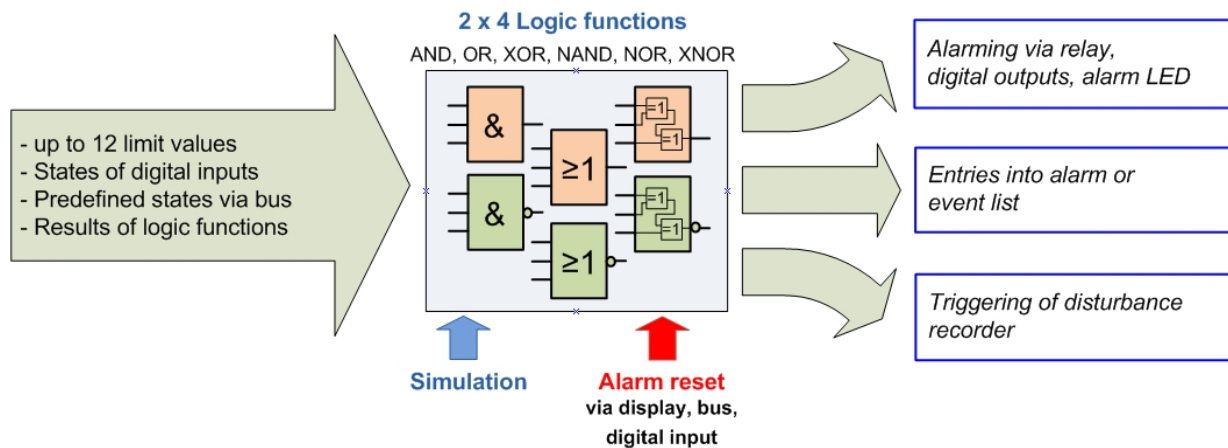

The principal function of the logical gates is given in the following table, for simplicity shown for gates with two inputs only.

| function | symbol | older symbols | | truth table | plain text |
|-------------|--------|---------------|-----------------|----------------------------|---|
| | | ANSI 91-1984 | DIN 40700 (alt) | | |
| AND | | | | A B Y | Function is true if all input conditions are fulfilled |
| | | | | 0 0 0 | |
| | | | | 0 1 0 | |
| | | | | 1 0 0 | |
| | | | | 1 1 1 | |
| NAND | | | | A B Y | Function is true if at least one of the input conditions is not fulfilled |
| | | | | 0 0 1 | |
| | | | | 0 1 1 | |
| | | | | 1 0 1 | |
| | | | | 1 1 0 | |
| OR | | | | A B Y | Function is true if at least one of the input conditions is fulfilled |
| | | | | 0 0 0 | |
| | | | | 0 1 1 | |
| | | | | 1 0 1 | |
| | | | | 1 1 1 | |
| NOR | | | | A B Y | Function is true if none of the input conditions is fulfilled |
| | | | | 0 0 1 | |
| | | | | 0 1 0 | |
| | | | | 1 0 0 | |
| | | | | 1 1 0 | |
| XOR | | | | A B Y | Function is true if exactly one of the input conditions is fulfilled |
| | | | | 0 0 0 | |
| | | | | 0 1 1 | |
| | | | | 1 0 1 | |
| | | | | 1 1 0 | |
| XNOR | | | | A B Y | Function is true if all of the input conditions are fulfilled or all conditions are not fulfilled |
| | | | | 0 0 1 | |
| | | | | 0 1 0 | |
| | | | | 1 0 0 | |
| | | | | 1 1 1 | |

The logic components of the first level may combine up to three, the components of the second level up to four input conditions. If individual inputs are not used, their state is automatically set to a condition which has no influence on the logic result.

3.3.3 Limit values

States of limit values are the most important input quantities of the logic module. Depending on the application, limits either monitor the exceeding of a given value (upper limit) or the fall below a given value (lower limit). Limits are defined by means of two parameters, the limit for the ON and the limit for the OFF state. The hysteresis is the difference between these two values.

Upper limit: The limit for ON state ($L.ON$) is higher than the limit for the OFF state ($L.OFF$)

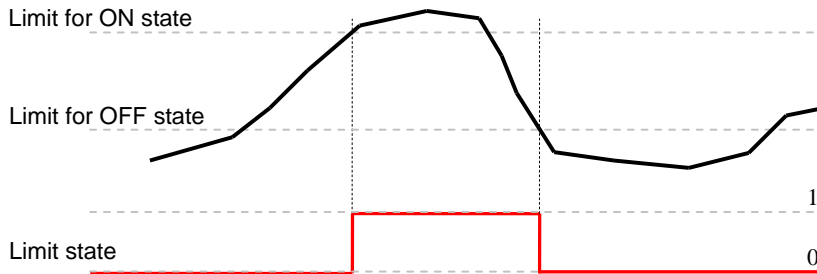

- ▶ The state 1 (true) results if the limit for ON state is exceeded. It remains until the value falls below the limit for OFF state again.
- ▶ The state 0 (false) results if the limit for ON state is not yet reached or if, following the activation of the limit value, the value falls below the limit for OFF state again.

Lower limit: The limit for ON state ($L.ON$) is smaller than the limit for OFF state ($L.OFF$)

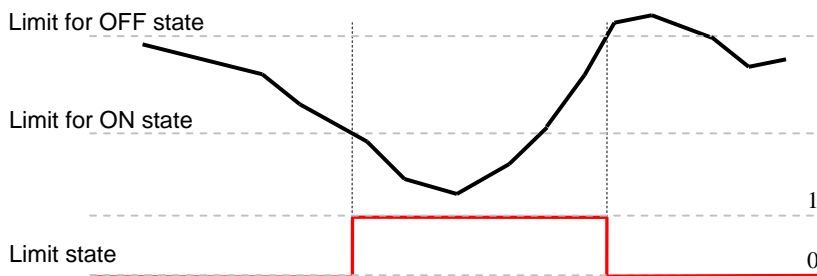

- ▶ The state 1 (true) results if the value falls below the limit for ON state. It remains until the value exceeds the limit for OFF state again.
- ▶ The state 0 (false) results if the value is higher than the limit for ON state or if, following the activation of the limit value, the value exceeds the limit for OFF state again.



If for a limit value the limit for ON state and the limit for OFF state are configured to the same value, it will be treated as an upper limit value with a hysteresis of 0%.

Limit values may be used to control the running of **operating hour counters**. As long as the limit values are fulfilled (logical 1) the operating hour counters keep on running. Not only operating times may be measured, but e.g. time under overload condition (additional stress) as well.

3.3.4 Sequence of evaluation

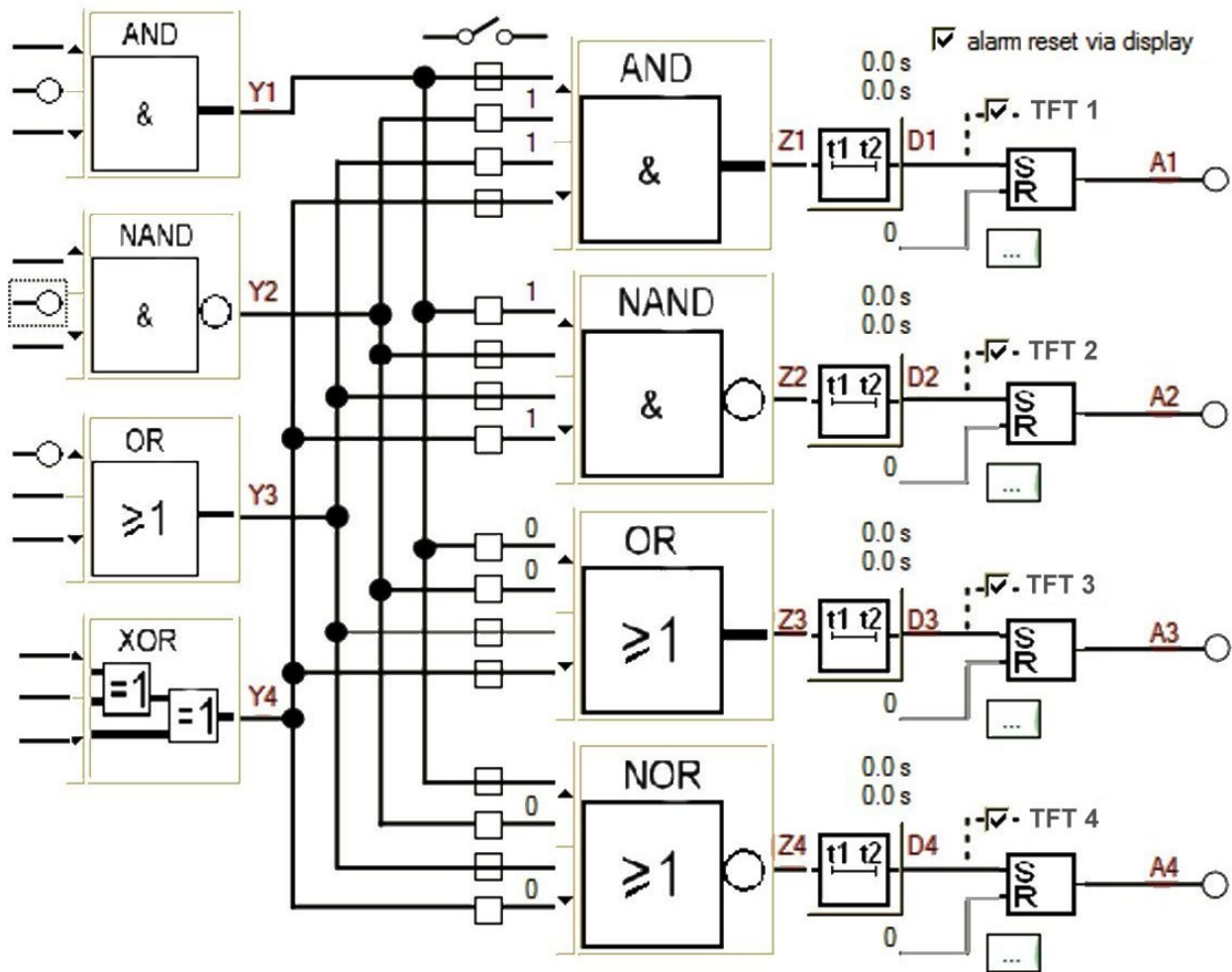

The evaluation of the logic module is performed from top to bottom and from left to right:

1. Y1, Y2, Y3, Y4
2. Z1, Z2, Z3, Z4
3. D1, D2, D3, D4
4. A1, A2, A3, A4

- ▶ The evaluation is performed once each cycle of the power frequency, e.g. every 20ms at 50Hz. But the time between two evaluations will never be longer than 25ms.
- ▶ If the logical states Y1...Y4, Z1...Z4, D1...D4 and A1...A4 are used as inputs, their changed states will be included in the evaluation of the next interval
- ▶ Exception: In the first evaluation level the state of previous logical functions may be used as input without delay, e.g. the state Y1 for the logical functions with output Y2, Y3 or Y4.

3.4 Free Modbus image

Accessing measured data of a Modbus device often needs some special effort, if the interesting measurements are stored in different, non continuous register areas. This way multiple telegrams must be sent to the device to read all data. This needs time and it's very likely, that the measurements don't originate from the same measurement cycle.

A free assembly of the data to read helps a lot. The *APLUS* supports, along with the still available classical Modbus image with thousands of registers, the facility to assemble two different images, which may be read with one telegram only. These freely assembled images are refreshed after each measurement cycle and therefore always provide the most present values.

The free float image

Up to 60 instantaneous, mean, unbalance or THD/TDD values may be arranged in any sequence on the register addresses 41840-41958. All of these values are floating point numbers, which allocate 2 registers per value. Meter values are not possible because they have another format.

The free integer image

Some older control systems are not able to handle float values. To make it possible to work with the data of the device up to 20 16-Bit integer values can be derived from the existing measurement values. These values will then be stored in the free Modbus image (register 41800 up to 41819) as integer values with selectable range of values.

Example: Current transformer 100/5A, measurement current phase 1, over range 20%

- ▶ The reference value is 120A (maximum measurable current)
- ▶ The integer value shall be 12'000 if the measurement is 120A

After selecting the measured quantity and entering the register value of 12'000 automatically a scaling factor of 100.0 is calculated. The measurement I1 therefore will be multiplied by 100.0 before it is converted into an integer value and stored in the Modbus image.

Also in the integer image instantaneous, mean, unbalance or THD/TDD values may be arranged.



For devices with Profibus interface the Modbus image is used for the assembly of the cyclical telegram. Via Modbus the same image can be used, but it's not possible to use it independently.

The Modbus communication of the *APLUS* is described in a separate document. Depending on the communication hardware selected, either the manual for Modbus/RTU or Modbus/TCP protocol should be used. These documents may be found on the software CD or can be downloaded via our homepage <http://www.camillebauer.com>.

- ▶ **W157 695: Modbus/RTU interface *APLUS* (communication interface RS485)**
- ▶ **W162 636: Modbus/TCP interface *APLUS* (communication interface Ethernet)**

4. Mechanical mounting

► The version of the *APLUS* with TFT display is designed for panel mounting as shown below



Please ensure that the operating temperature limits are not exceeded when determining the place of mounting (place of measurement):

-10 ... 55°C

4.1 Panel cutout

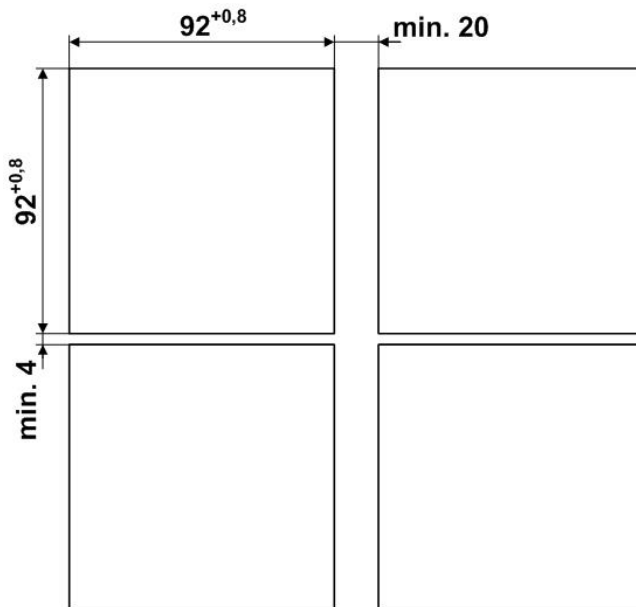

Dimensional drawing *APLUS*:

[See section 10](#)

4.2 Mounting of the device

The *APLUS* is suitable for panel widths up to 10mm.

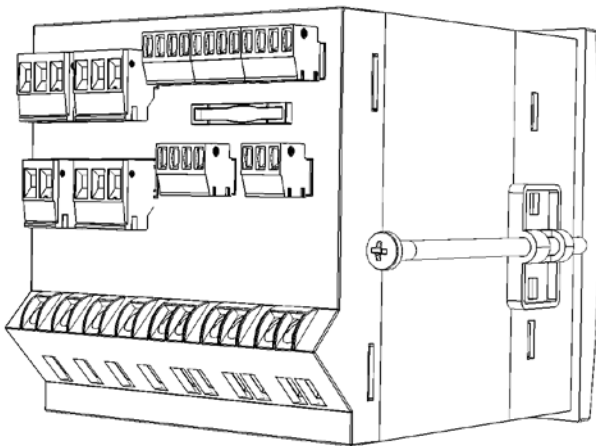

- Slide the device into the cutout from the outside
- From the side slide in the mounting clamps into the intended openings and pull them back about 2 mm
- Tighten the fixation screws until the device is tightly fixed with the panel

4.3 Demounting of the device

The demounting of the device may be performed only if all connected wires are out of service. Remove all plug-in terminals and all connections of the current and voltage inputs. Pay attention to the fact, that current transformers must be shortened before removing the current connections to the device. Then demount the device in the opposite order of mounting (4.2).

5. Electrical connections



Ensure under all circumstances that the leads are free of potential when connecting them !

5.1 General safety notes



Please observe that the data on the type plate must be adhered to !

The national provisions (e.g. in Germany VDE 0100 "Conditions concerning the erection of heavy current facilities with rated voltages below 1000 V") have to be observed in the installation and material selection of electric lines!

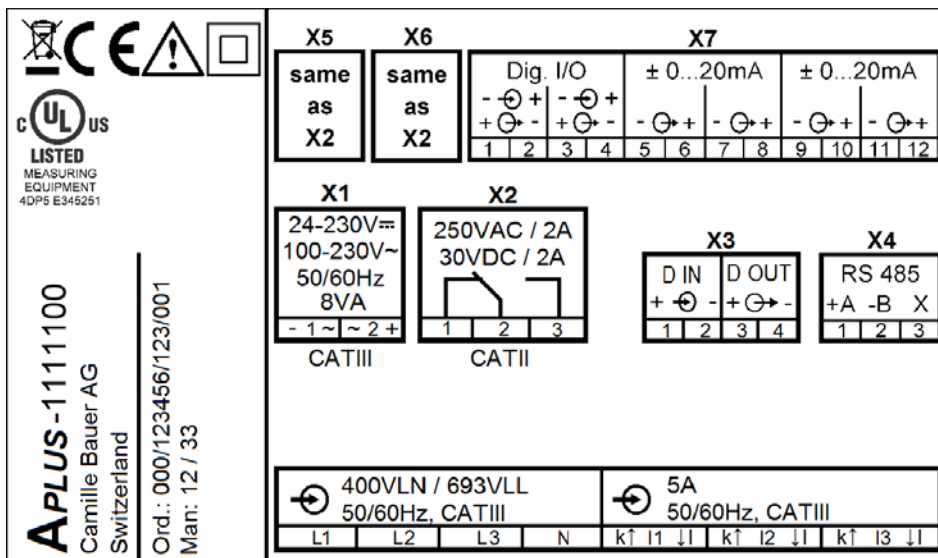

Nameplate of a device equipped with RS485 interface and I/O extension 1

| Symbol | Meaning |
|---------|---|
| | Device may only be disposed of in a professional manner! |
| | Double insulation, device of protection class 2 |
| | CE conformity mark. The device fulfills the requirements of the applicable EC directives. See declaration of conformity . |
| | Products with this mark comply with both the Canadian (CSA) and the American (UL) requirements. |
| | Caution! General hazard point. Read the operating instructions. |
| | General symbol: Input |
| | General symbol: Output |
| CAT III | Measurement category CAT III for current / voltage inputs and power supply |
| CAT II | Measurement category CAT II for relay outputs |

5.2 Electrical connections of the I/Os

| I/O no. | Terminal | No. | APLUS | I/O extension 1 | I/O extension 2 |
|---------|----------|---------|----------------|---------------------------------|-----------------|
| 1 | X2 | 1, 2, 3 | Relay | | |
| 2 | X3 | 1, 2 | Digital input | | |
| 3 | X3 | 3, 4 | Digital output | | |
| 4 | X5 | 1, 2, 3 | | Relay | Relay |
| 5 | X6 | 1, 2, 3 | | Relay | Relay |
| 6 | X7 | 1, 2 | | Digital I/O | Digital I/O |
| 7 | X7 | 3, 4 | | Digital I/O | Digital I/O |
| 8 | X7 | 5, 6 | | Analog output $\pm 20\text{mA}$ | Digital I/O |
| 9 | X7 | 7, 8 | | Analog output $\pm 20\text{mA}$ | Digital I/O |
| 10 | X7 | 9, 10 | | Analog output $\pm 20\text{mA}$ | Digital I/O |
| 11 | X7 | 11, 12 | | Analog output $\pm 20\text{mA}$ | Digital I/O |

I/O no. - as used in the CB-Manager software

5.3 Possible cross sections and tightening torques

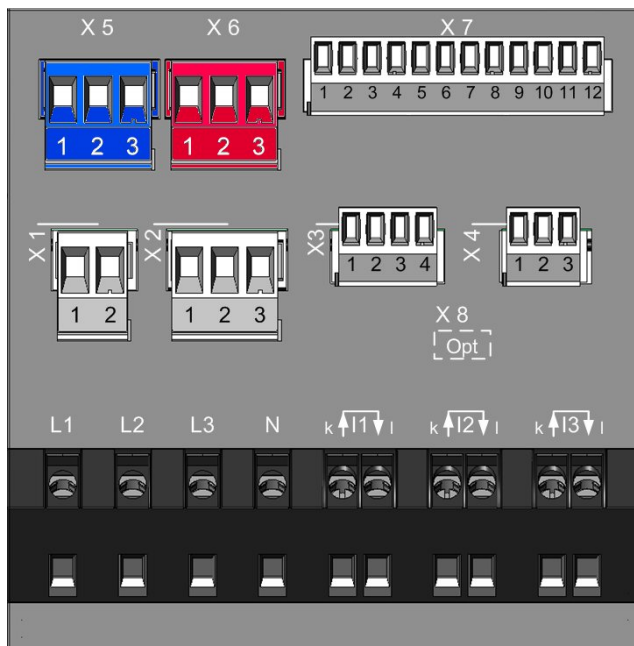

Inputs L1, L2, L3, N, I1 k-I, I2 k-I, I3 k-I

Single wire

1 x 0,5 ... 4,0mm² or 2 x 0,5 ... 2,5mm²

Multiwire with end splices

1 x 0,5 ... 2,5mm² or 2 x 0,5 ... 1,5mm²

Tightening torque

0,5...0,6Nm resp. 4,42...5,31 lbf in

Power supply X1, Relays X2, X5, X6

Single wire

1 x 0,5 ... 2,5mm² or 2 x 0,5 ... 1,0mm²

Multiwire with end splices

1 x 0,5 ... 2,5mm² or 2 x 0,5 ... 1,5mm²

Tightening torque

0,5...0,6Nm resp. 4,42...5,31 lbf in

I/O's X3, X7 and RS485 connector X4

Single wire

1 x 0,5 ... 1,5mm² or 2 x 0,25 ... 0,75mm²

Multiwire with end splices

1 x 0,5 ... 1,0mm² or 2 x 0,25 ... 0,5mm²

Tightening torque

0,2...0,25Nm resp. 1,77...2,21 lbf in

5.4 Inputs



All voltage measurement inputs must originate at circuit breakers or fuses rated 10 Amps or less. This does not apply to the neutral connector. You have to provide a method for manually removing power from the device, such as a clearly labeled circuit breaker or a fused disconnect switch.

When using **voltage transformers** you have to ensure that their secondary connections never will be short-circuited.



No fuse may be connected upstream of the **current measurement inputs** !

When using **current transformers** their secondary connectors must be short-circuited during installation and before removing the device. Never open the secondary circuit under load.

The connection of the inputs depends on the configured system (connection type). The required device external fusing of the voltage inputs is not shown in the following connection diagrams.

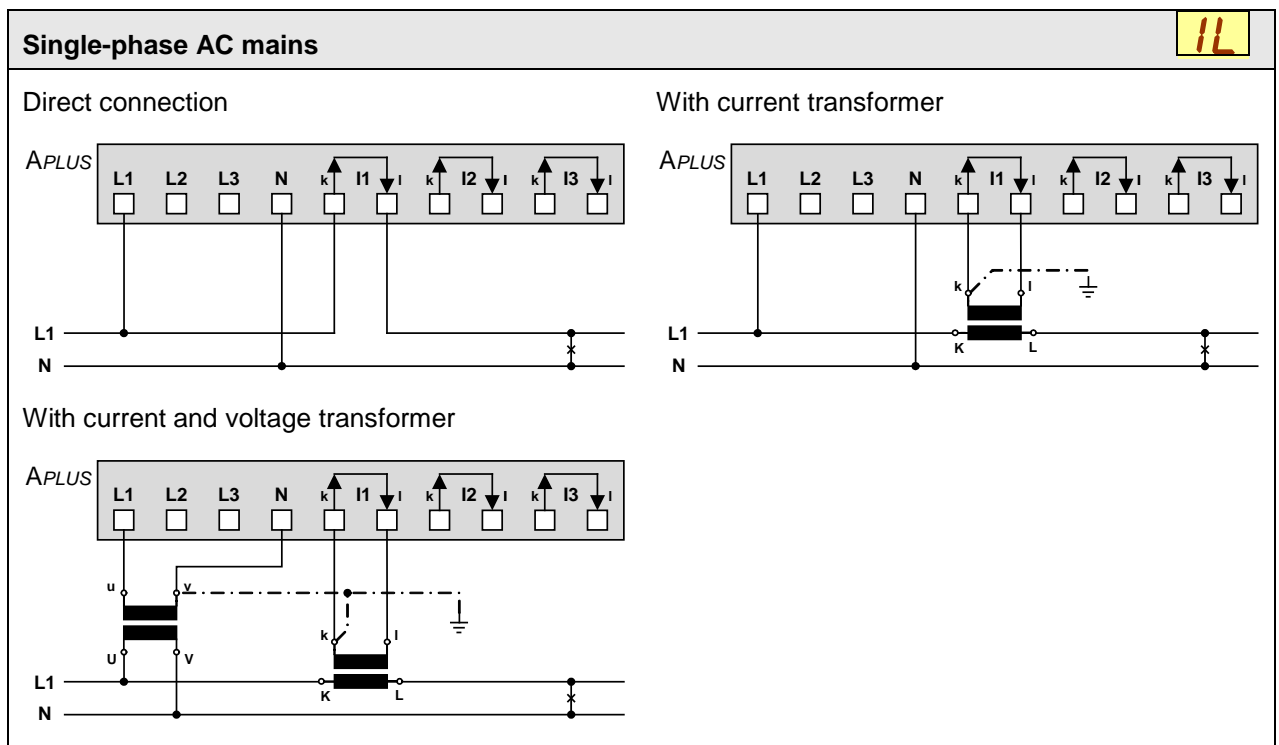

Three wire system, balanced load, current measurement via L1

3L.6

Direct connection

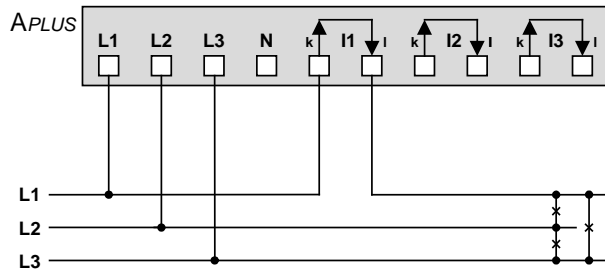

With current transformer

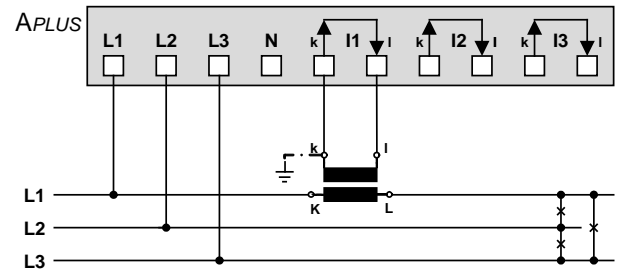

With current and voltage transformer

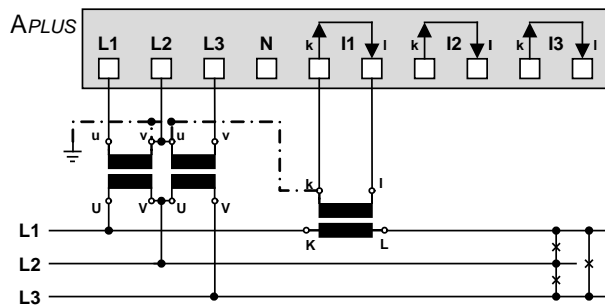

In case of current measurement via L2 or L3 connect voltages according to the following table:

| Current | Terminals | L1 | L2 | L3 |
|---------|-----------|----|----|----|
| L2 | I1-k I1-I | L2 | L3 | L1 |
| L3 | I1-k I1-I | L3 | L1 | L2 |

 By rotating the voltage connections the measurements U12, U23 and U31 will be assigned interchanged !

Four wire system, balanced load, current measurement via L1

4L.6

Direct connection

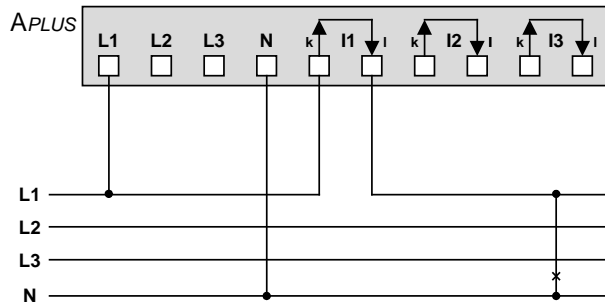

With current transformer

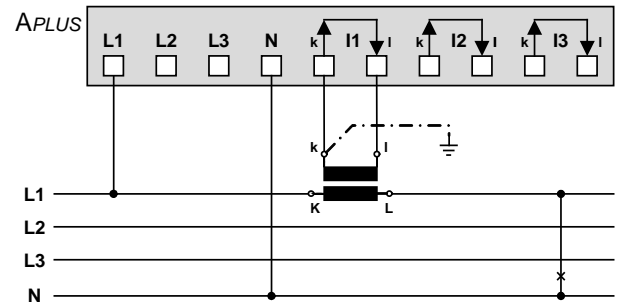

With current and voltage transformer

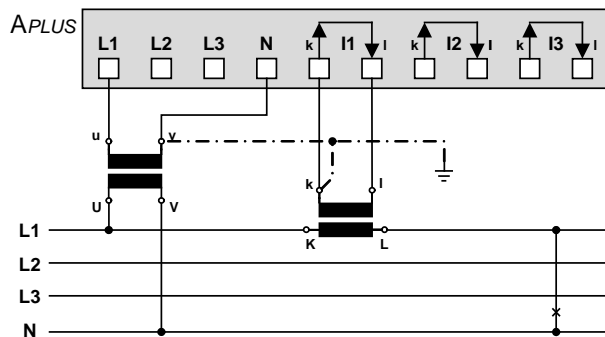

In case of current measurement via L2 or L3 connect voltages according to the following table:

| Current | Terminals | L1 | N |
|---------|-----------|----|---|
| L2 | I1-k I1-I | L2 | N |
| L3 | I1-k I1-I | L3 | N |

Three wire system, unbalanced load

3LUB

Direct connection

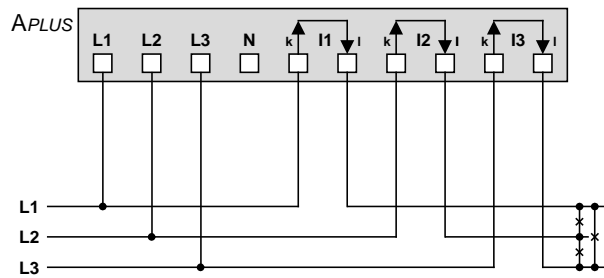

With current transformers

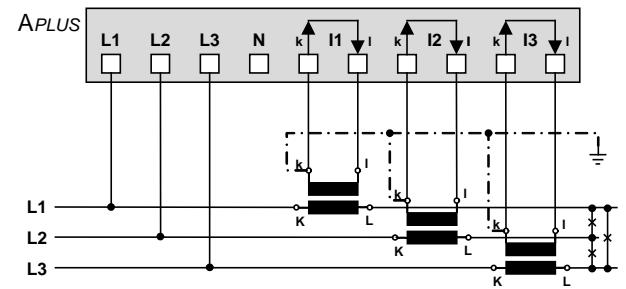

With current and 3 single-pole isolated voltage transformers

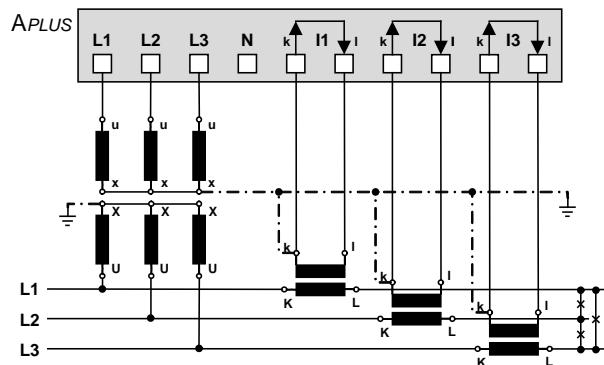

Three wire system, unbalanced load, Aron connection

3LUA

Direct connection

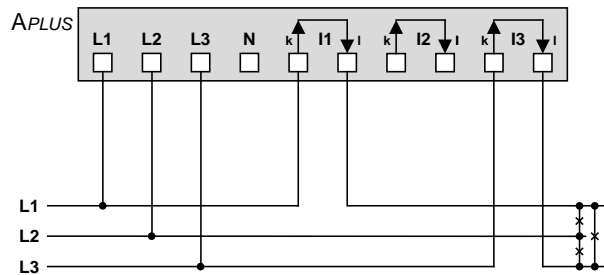

With current transformers

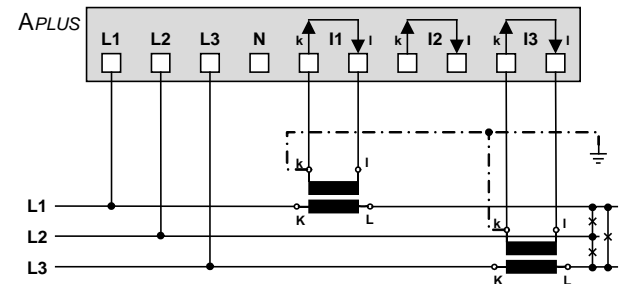

With current and 3 single-pole isolated voltage transformers

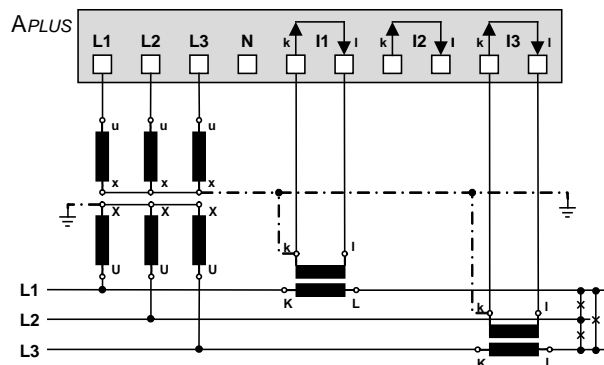

Four wire system, unbalanced load

4L.U6

Direct connection

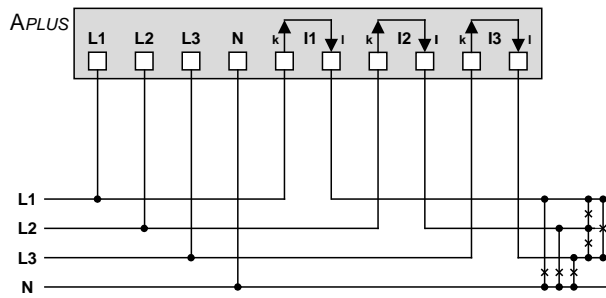

With current transformers

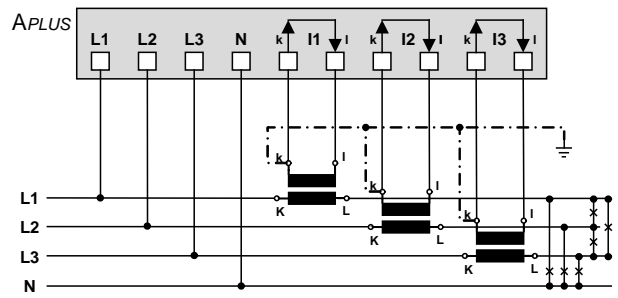

With current and 3 single-pole isolated voltage transformers

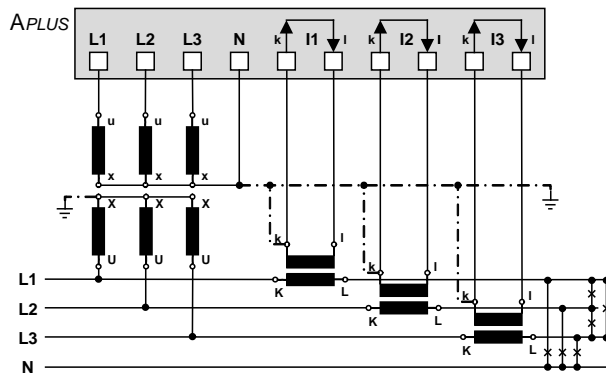

Four wire system, unbalanced load, Open-Y

4L.U4

Direct connection

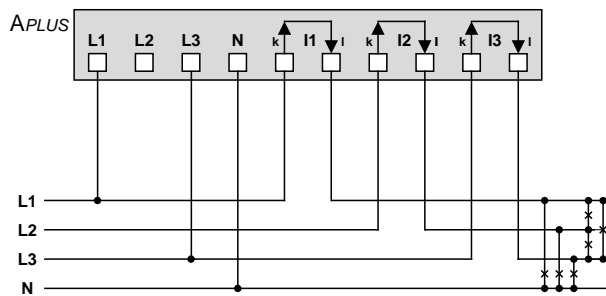

With current transformers

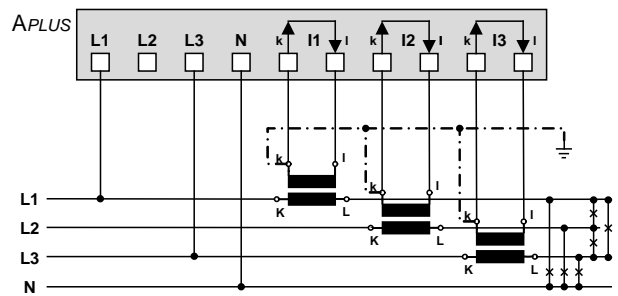

With current and 2 single-pole isolated voltage transformers

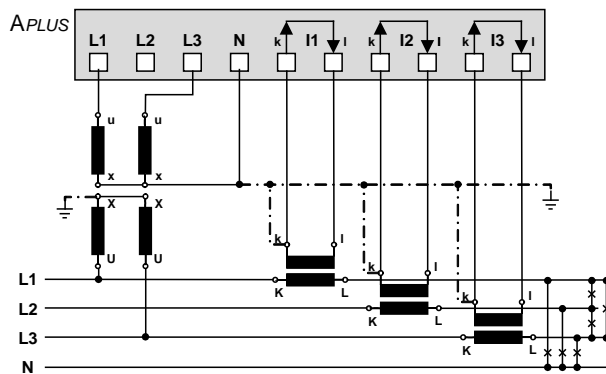

Direct connection

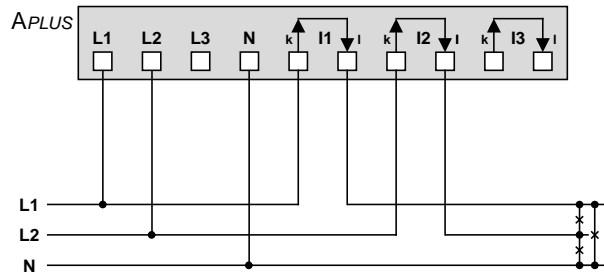

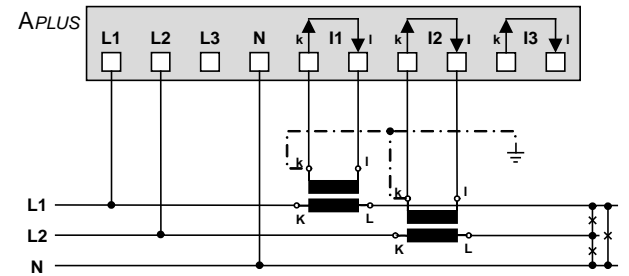

With current transformers

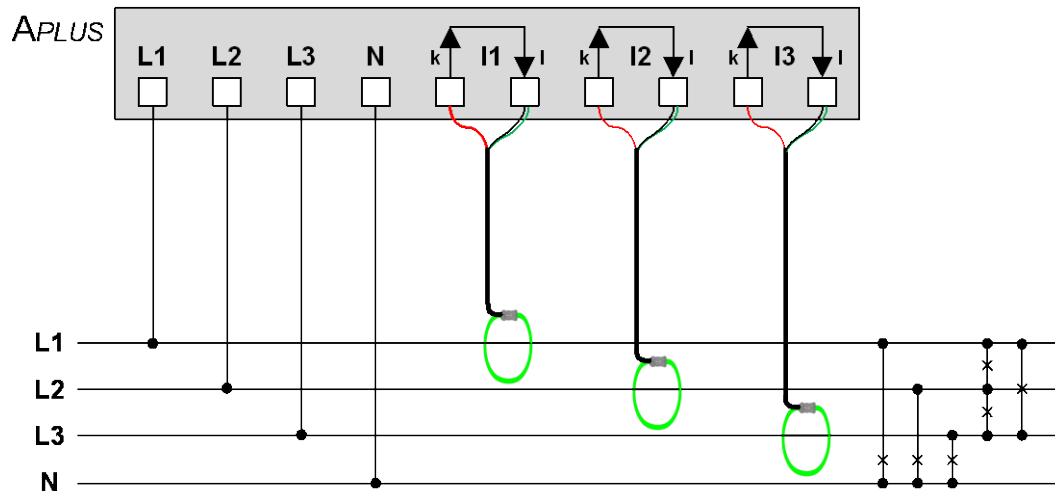

5.5 Rogowski current inputs

The connection of the Rogowski coils is performed depending on the selected system type, as shown in chapter 5.4 above. However, instead of current transformers a Rogowski coils is placed around each current-carrying conductor. This is subsequently shown for the measurement in a 4-wire low-voltage system.



 When connecting the coils you must follow the safety notices given in the operating instructions of the Rogowski coil. The current direction shown on the coils must match the real current direction and has to be the same for all phases.

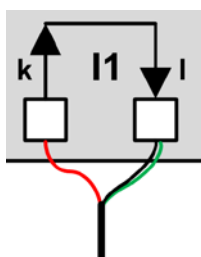
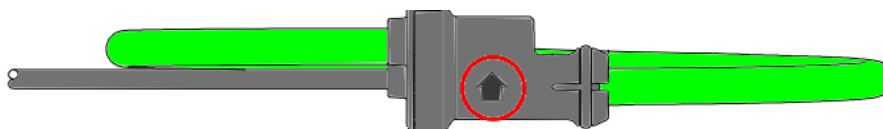

In order to suppress injected interferences the shielding (green) is connected always to the I terminal of the current inputs (I1-I, I2-I resp. I3-I).

5.6 Power supply



A marked and easily accessible current limiting switch has to be arranged in the vicinity of the device for turning off the power supply. Fusing should be 10 Amps or less and must be rated for the available voltage and fault current.

5.7 Relays



When the device is switched off the relay contacts are de-energized, but dangerous voltages may be present.

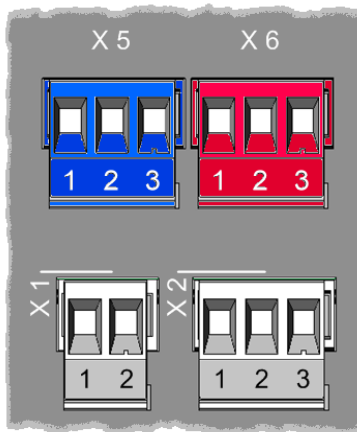

The relay X2 is part of the basic unit and therefore always available. The relays X5 and X6 are provided for device versions with I/O extension PCB only.

The plug-in terminals have different colours to prevent mixing up the connections. The pin assignment is the same for all relays:

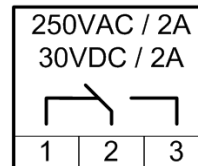

5.8 Digital inputs and outputs

For the digital inputs / outputs an external power supply of 12 / 24V DC is required.



The power supply shall not exceed 30V DC !

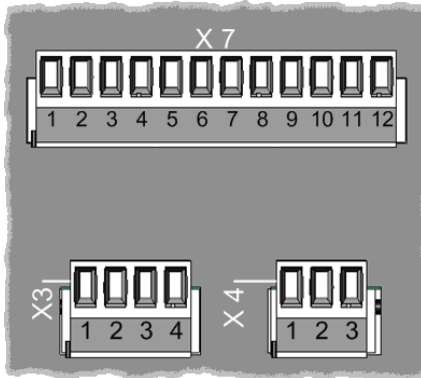

The plug-in terminal X7 is available for device versions with I/O extension PCB only.

The number of digital inputs / outputs varies depending on the optional built-in PCB, see nameplate. The operating direction of the digital I/Os on X7 may be individually selected by means of the PC software.



The assignment of the connections depends on whether an I/O is configured to be a digital input or a digital output.

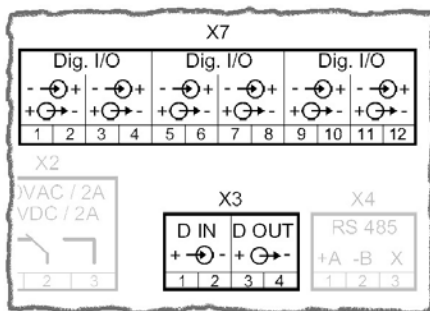

Example

Device with I/O extension 2 (2 relays + 6 digital I/Os)

The digital I/Os on **plug-in terminal X7** are individually programmable as input \rightarrow or output \leftarrow

On **plug-in terminal X3** a digital input and a digital output are provided statically. Their operating direction may not be modified.

Usage as digital input

- ▶ Meter tariff switching
- ▶ Operating feedback of loads for operating time counters
- ▶ Trigger and release signal for logic module
- ▶ Pulse input for meters of any kind of energy
- ▶ Clock synchronization
- ▶ Synchronization of billing intervals in accordance with energy provider

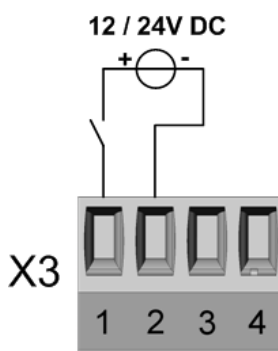

Technical data

| | |
|-------------------------|-----------------|
| Input current | < 7,0 mA |
| Counting frequency (S0) | ≤ 16 Hz |
| Logical ZERO | - 3 up to + 5 V |
| Logical ONE | 8 up to 30 V |

Usage as digital output

- ▶ Alarm output for logic module
- ▶ State reporting
- ▶ Pulse output to an external counter (acc. EN62053-31)
- ▶ Remote controllable state output via bus interface

Driving a relay

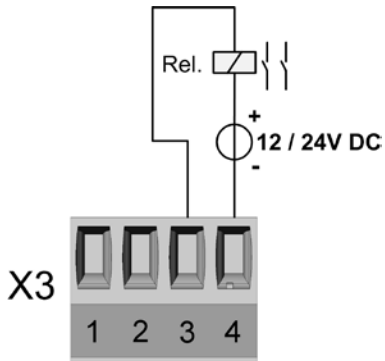

Technical data

| | |
|--------------------------|--------------------|
| Rated current | 50 mA (60 mA max.) |
| Switching frequency (S0) | ≤ 20 Hz |
| Leakage current | 0,01 mA |
| Voltage drop | < 3 V |
| Load capacity | 400 Ω ... 1 MΩ |

Driving a counter mechanism

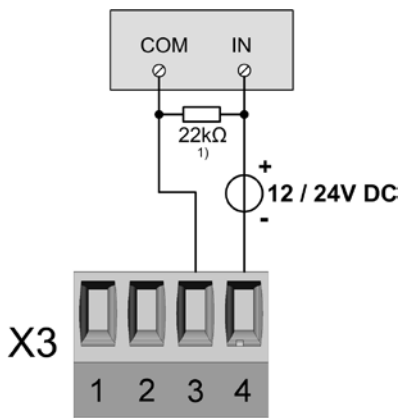

1) Recommended if input impedance of counter > 100 kΩ

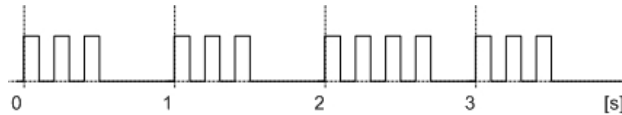

The width of the energy pulses can be selected by means of the PC software but have to be adapted to the counter mechanism. Once a second there is a decision how many pulses have to be output.

Therefore the delay between two pulses may not be used to determine the present power demand.

Electro mechanical meters typically need a pulse width of 50...100ms.

Electronic meters are partly capable to detect pulses in the kHz range. There are the types NPN (active negative edge) and PNP (active positive edge). For the *APLUS* a PNP type is required. The pulse width has to be at least **30ms** (acc. EN62053-31). The delay between to pulses corresponds at least to the pulse width. The smaller the pulse width, the higher the sensitivity to disturbances.

5.9 Analog outputs

Analog outputs are available for devices with I/O extension 1 only. See nameplate.

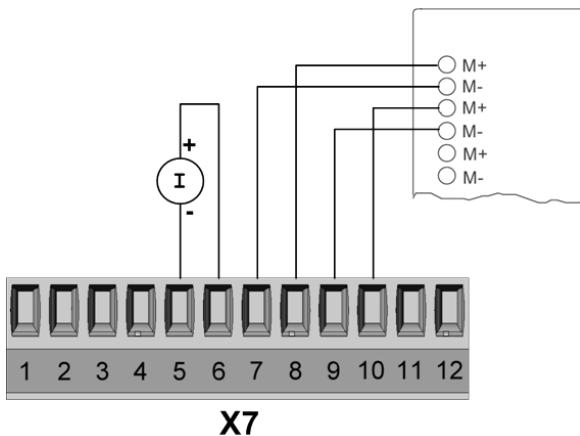

Connection to an analog input card of a PLC or a control system

The *APLUS* is an isolated measurement device. In addition the particular outputs are galvanically isolated. To reduce the influence of disturbances shielded twisted-pair cables should be used. The shield should be connected to earth on both opposite ends. If there are potential differences between the ends of the cable the shield should be earthed on one side only to prevent from equalizing currents.

Under all circumstances consider as well appropriate remarks in the instruction manual of the system to connect.

5.10 Modbus interface RS485 X4 and / or X8

Depending on the device version up to two Modbus interfaces are available on the plug-in positions X4 and / or X8. These are galvanically isolated. The connection terminals are distinguished by color: X4 (gray), X8 (black).

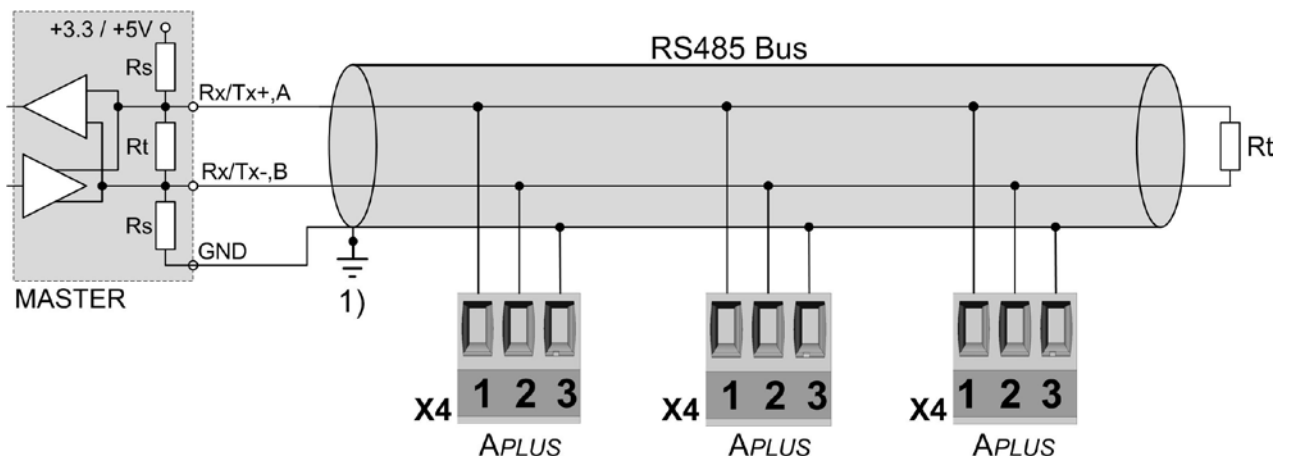

1) One ground connection only. This is possibly made within the master (PC).

Rt: Termination resistors: 120 Ω each for long cables (> approx. 10 m)

Rs: Bus supply resistors, 390 Ω each

The signal wires (X4-1, X4-2 resp. X8-1, X8-2) have to be twisted. GND (X4-3 resp. X8-3) can be connected via a wire or via the cable screen. In disturbed environments shielded cables must be used. Supply resistors (Rs) have to be present in bus master (PC) interface. Stubs should be avoided when connecting the devices. A pure daisy chain network is ideal.

You may connect up to 32 Modbus devices to each bus. A proper operation requires that all devices connected to the respective bus have equal communication settings (baud rate, transmission format) and unique Modbus addresses. If there are two Modbus interfaces, their settings may be different.

The bus system is operated half duplex and may be extended to a maximum length of 1200 m without repeater.

5.11 Profibus DP interface

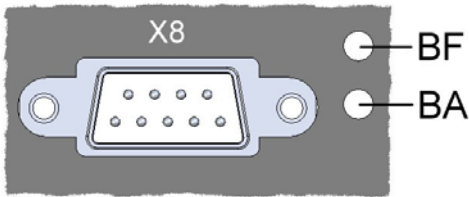

The 9-pin DSUB socket serves the connection of a standard Profibus plug. In a bus terminal device, the bus line must be terminated with resistors in the bus plug. Then standard pin assignment is as follows:

| Pin | Name | Description |
|-----|------|-------------------------------|
| 3 | B | RxD/TxD-P |
| 4 | RTS | Request to send: CNTR-P (TTL) |
| 5 | GND | Data ground |
| 6 | +5V | VP |
| 8 | A | RxD/TxD-N |

LED BF (Bus failure, yellow)

| Status | Description |
|----------------|---|
| ON | Startup state or internal communication error |
| Flashing (2Hz) | Parameterization check failed |
| OFF | Cyclical operation; no error |

LED BA (Bus alive, green)

| Status | Description |
|----------------|---|
| OFF | Startup state; no Profibus communication |
| Flashing (2Hz) | Profibus detected; waiting for parameterization from master |
| ON | Parameterization ok; Profibus communication active |

6. Commissioning



Before commissioning you have to check if the connection data of the transducer match the data of the plant (see nameplate).

If so, you can start to put the device into operation by switching on the power supply and the measurement inputs.

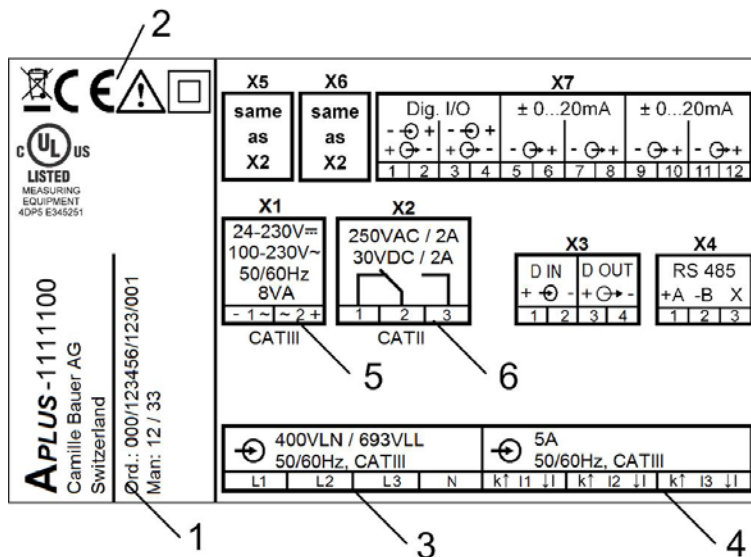

⊕ Measurement input

Input voltage
Input current
System frequency

- 1 Works no.
- 2 Test and conformity marks
- 3 Assignment voltage inputs
- 4 Assignment current inputs
- 5 Assignment power supply
- 6 Load capacity relay outputs

6.1 Software installation CB-Manager

A complete parametrization of the device is possible via configuration interface only, using the supplied PC software CB-Manager. The software may also be downloaded free of charge from our homepage <http://www.camillebauer.com>.



The file "Read-me-first" on the Doku-CD provides all necessary information for the installation of the CB-Manager software and assistance for possible problems.

Functionality of the CB-Manager software

The software is primary a tool for the configuration of different devices (*APLUS*, CAM, VR660, A200R, V604s) and supports the user during commissioning and service. It allows as well the reading and visualization of measured data.

- ▶ Acquisition and modification of all device features
- ▶ Setting of real-time clock and time zone, selection of time synchronization method
- ▶ Archiving of configuration and measurement files
- ▶ Visualization of present measurements
- ▶ Reading, setting and resetting of meters
- ▶ Reading and resetting of minimum/maximum values
- ▶ Starting, stopping and resetting of the optional data logger
- ▶ Recording of measurement progressions during commissioning
- ▶ Check for correct device connection
- ▶ Simulation of states or outputs to test subsequent circuits
- ▶ Adjust the security system as protection against unauthorized access or manipulations

The CB-Manager software provides a comprehensive help facility, which describes in detail the operation of the software as well as all possible parameter settings.

6.2 Parametrization of the device functionality

Operating the software

The device configuration is divided into registers, which contain thematically the different function blocks of the device, e.g. "input", "limit values", "display". Thereby of course there are interdependencies, which have to be considered. If e.g. a current limit value is defined and subsequently the ratio of the current transformer is changed, there is a high probability that the limit value is changed as well. Therefore a meaningful sequence must be kept during setting the parameters. The easiest way is to handle register by register and line by line:

- ▶ **Device** (set the device version, if not read directly from the device)
 - If an I/O extension unit is used: Fix the data direction of the digital I/O's. Do to so just click on the appropriate entry and change the data direction in the I/O register. So it's assured that these I/O's can be used in the intended way. If e.g. you miss to change de basic setting "digital input" the appropriate channel can't be used as output in the logic module.*
- ▶ **Input**, especially system and transformer ratios
- ▶ **Mean values >> Limit values >> Logic module >> I/O 1-3**
- ▶ if present: **I/O 4,5 >> I/O 6,7 >> I/O 8,9 >> I/O 10,11**
- ▶ **Operating hours**
- ▶ if present: **Logger >> Interface (Ethernet, Profibus DP) >> Display (TFT)**
- ▶ **Modbus-Image** (if you want to define your own Modbus image)
- ▶ **Time zone** (for automatical handling of daylight saving time)

| I/O 10,11 | Operating hours | Logger | Interface | Display | Display (TFT) | Modbus Image | Time zone | |
|--|-----------------|--|--------------|---|---------------|---------------------|-----------|---------|
| Device | Input | Mean values | Limit values | Logic module | I/O 1-3 | I/O 4,5 | I/O 6,7 | I/O 8,9 |
| device | | Aplus | | ID | 460193792 | | | |
| description | | APLUS | | | | | | |
| TAG | | WSI_APLUS_kpl | | | | | | |
| firmware version | | | | device type | | | | |
| input | 0.00.0000 | | | <input type="checkbox"/> logger | Bus | 2x RS485 MODBUS/RTU | | |
| Analysis | 1.22.1668 | | | <input type="checkbox"/> LED display | NLB | 0 | | |
| Bus | 1.00.0040 | | | <input checked="" type="checkbox"/> TFT display | memory | 0.00 MBytes | | |
| I/O's | 1.00.0014 | | | <input type="checkbox"/> Rogowski | | | | |
| display | 0.00.0000 | | | | | | | |
| MODBUS | | | | I/O's | | | | |
| | | <input checked="" type="radio"/> X4 <input type="radio"/> X8 | | 2 Relais + 2 Digital I/O + 4 Analog Out | | | | |
| device address | 12 | 147 | | | | | | |
| baudrate | 2400 | 57600 | | | | | | |
| parity | even | none | | | | | | |
| data bits | 8 | 8 | | | | | | |
| stopbits | 1 | 1 | | | | | | |
| <input type="checkbox"/> Security system | | | | 1 | 4 | 8 | | |
| | | | | 2 | 5 | 9 | | |
| | | | | 3 | 6 | 10 | | |
| | | | | | 7 | 11 | | |

ONLINE / OFFLINE

The parametrization may be performed ONLINE (with existing connection to the device) or OFFLINE (without connection to the device). To perform an ONLINE configuration first the configuration of the connected device, and therewith its hardware version, is read. A modified configuration can then be downloaded to the device and stored on the hard disk of the computer for archiving.

An OFFLINE parametrization can be used to prepare device configurations, to store them on disk and to download it to the devices, once you are in the field where the devices are installed. To make this work, the device versions selected during parametrization must agree with the versions on site.

6.3 Installation check

Check if inputs are connected correctly

- ▶ Voltage (at least 20% U_{rated}) and current (at least 2% I_{rated}) must be present

Using the connection check, which is integrated in the visualization of the instantaneous values, the correct connection of the current and voltage inputs may be checked. The phase sequence will be checked, as well as if there are open connections or reversed current connections (which change the direction of the current).

The image below shows open current connections (red description I1, I2, I3). This arises because the individual currents are below 2% of the rated value.

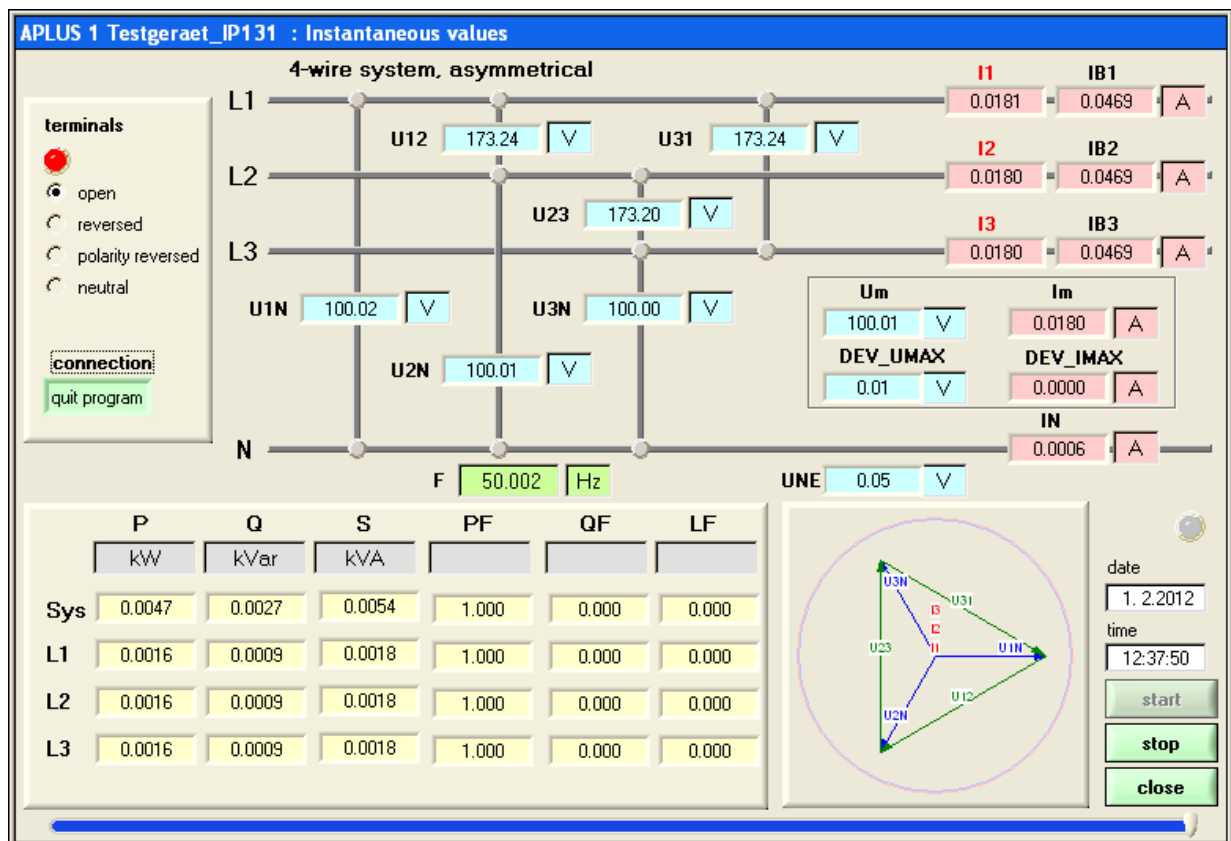

Simulation of I/O's

To check if subsequent circuits will work properly with the measurement data provided by the APLUS all analog, digital and relay outputs may be simulated, by predefining any output value resp. discrete state by means of the CB-Manager software.

Also all functions of the logic module, which allows performing any combination of logical states, may be predefined. This way e.g. an alarming due to a violation of a limit value can be simulated.

6.4 Installation of Ethernet devices

6.4.1 Connection

Before devices can be connected to an existing Ethernet network, you have to ensure that they will not disturb the normal network service. The rule is:



None of the devices to connect is allowed to have the same IP address than another device already installed

The factory setting of the IP address of *APLUS* is: 192.168.1.101

The standard RJ45 connector serves for direct connecting an Ethernet cable. If the PC is directly connected to the device a cross-wired cable must be used.

The network installation of the devices is done by means of the CB-Manager software (see [6.4.2](#)) or directly via the local programming on the display. As soon as all devices have a unique network address they may be accessed by means of a suitable Modbus master client.

- Interface: RJ45 connector, Ethernet 100BaseTX
- Mode: 10/100 MBit/s, full / half duplex, Auto-negotiation
- Protocols: Modbus/TCP, NTP

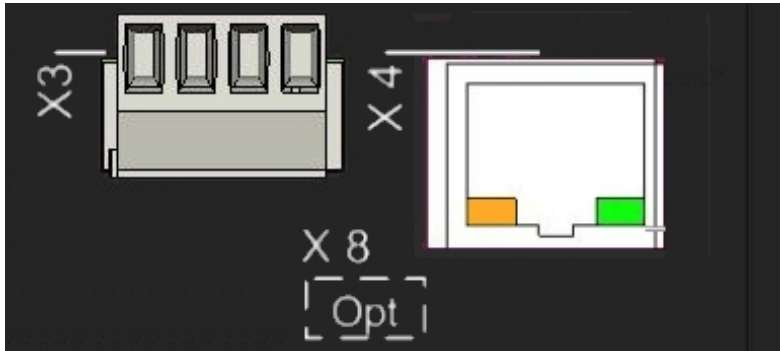

Function of the LED's

| | |
|----------------|--|
| LED 1 (Green) | <ul style="list-style-type: none"> • ON as soon as a network connection exists • Flashing when data is transmitted via Ethernet connection |
| LED 2 (Orange) | <ul style="list-style-type: none"> • Flashing with 4 Hz during start-up • ON during Modbus/TCP communication with the device |

APLUS-1111100
Camille Bauer AG
Switzerland

Mat.: 123456 / 1234567/ 001
Man.: 09/39
MAC: 00:12:34:AE:00:01

LISTED MEASURING EQUIPMENT 4DP5 E345251

UL US

CE

E

!

□

X sat at X

24-100-1

X

To have a unique identification of Ethernet devices in a network, to each connection a unique MAC address is assigned. This address is given on the nameplate, in the example 00-12-34-AE-00-01.

Compared to the IP address, which may be modified by the user any time, the MAC address is statically.

6.4.2 Network installation using the CB-Manager software

For the subsequent Modbus/TCP communication a unique network address must be assigned to each of the devices. This can be done very easily, using the CB-Manager software to search for devices which have a MAC address 00-12-34-AE-xx-xx, which identifies the device as *APLUS* of Camille Bauer. Because this is performed by means of a UDP broadcast telegram, the devices are allowed to have the same network address at the beginning, e.g. "192.168.1.101" as factory default.

As soon as to all the devices network settings with unique IP address have been assigned, they may be accessed and read using the Modbus/TCP protocol.

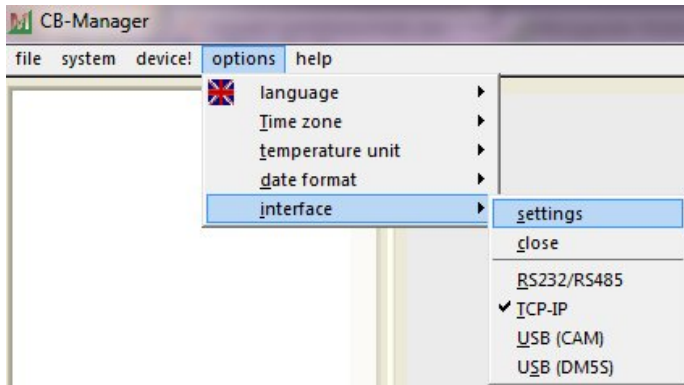

Select "settings" under options | interface. The interface type has to be set to "TCP-IP".

Devices in the local network

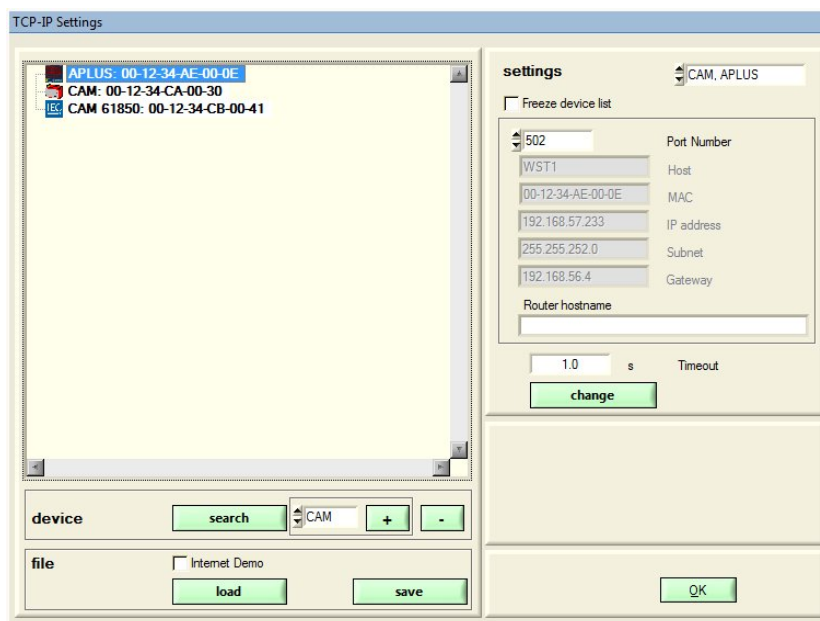

Set settings to "CAM, APLUS". Along with all *APLUS* also SINEAX CAM devices installed in the same network will be shown. The identification of the devices is possible by means of their MAC address, which is given on the nameplate (see [chapter 6.4.1](#)).

To assign a **unique** network address to a device, select it in the list and the click on "change".

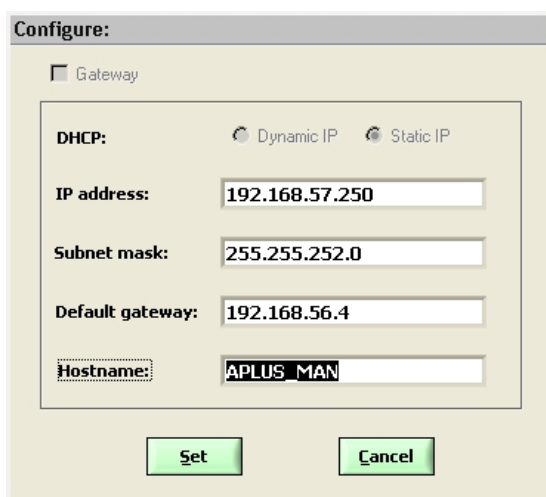

The following settings have to be arranged with the network administrator:

- **IP address:** This one must be **unique**, i.e. may be assigned in the network only once.
- **Subnet mask:** Defines how many devices are directly addressable in the network. This setting is equal for all the devices.
- **Default gateway:** Is used to resolve addresses during communication between different networks. Should contain a valid address within the own network.
- **Hostname:** Individual designation for each device. Helps to identify the device in the device list.

Example

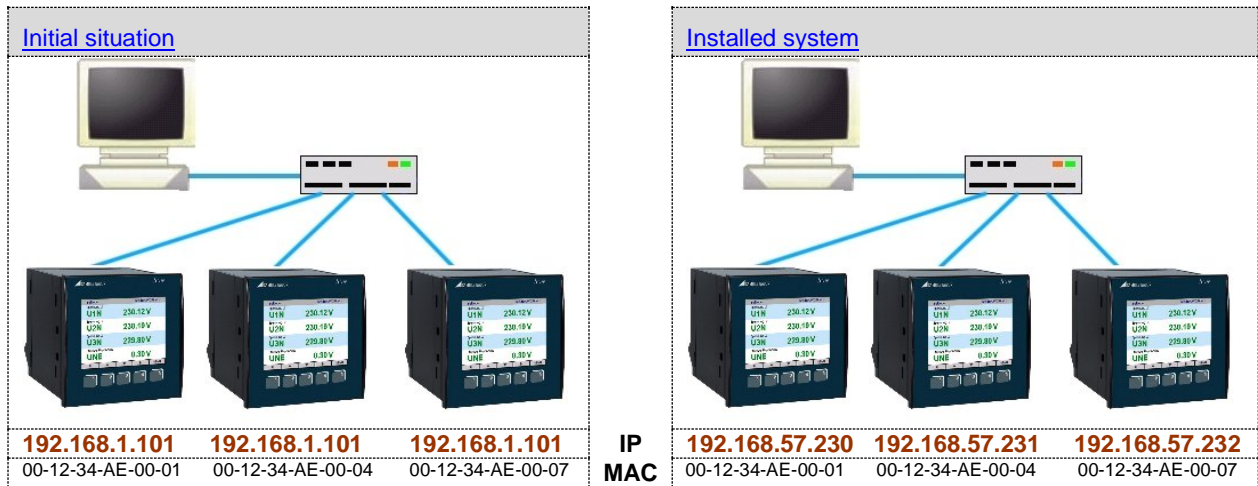

Devices outside the local network

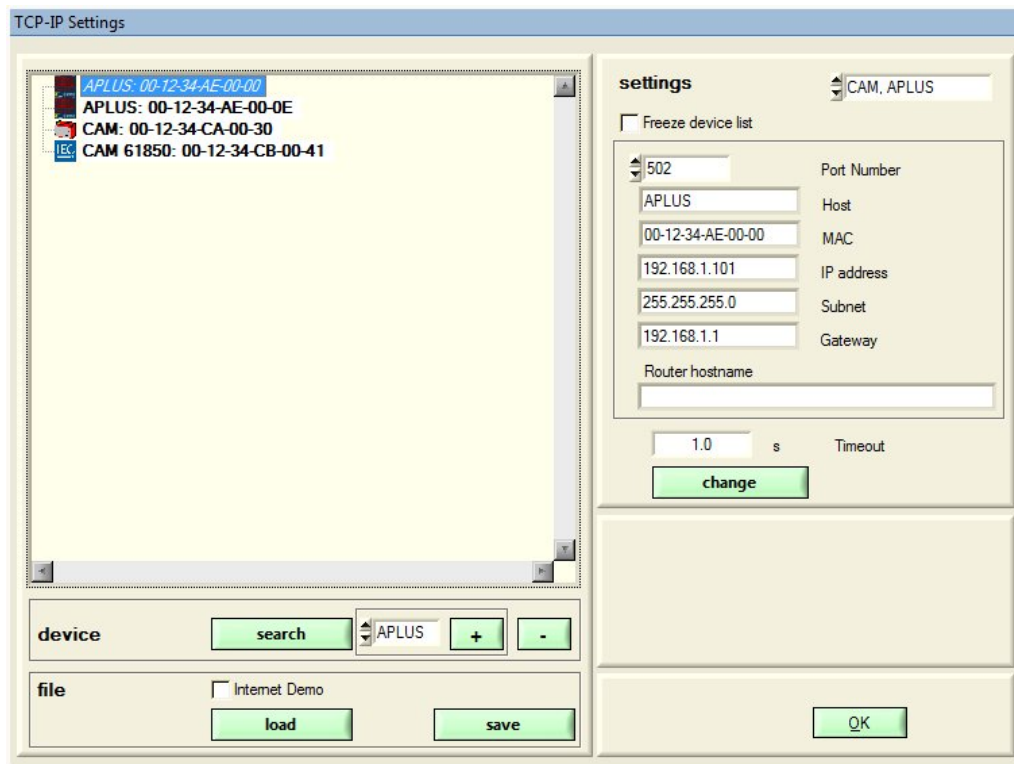

Devices which are not in the same network as the PC (e.g. in the Internet) can not be found and have to be added manually to the device list by means of **+**. The type of the device must be selected previously. To each entry you have to assign a unique IP and MAC address, which are different from the initial value. Otherwise it's not possible to add further entries.

The setting of the network parameters must be performed before mounting the device. As an alternative this may be done in the destination network via Ethernet interface.

6.4.3 Network installation by means of local programming

The network settings IP address, subnet mask and gateway can also be configured directly via the local programming of the APLUS on site.

6.4.4 Time synchronization via NTP-protocol

For the *time synchronization* via Ethernet *NTP* (Network Time Protocol) is the standard. Corresponding time servers are used in computer networks, but are also available for free via Internet. Using NTP it's possible to hold all devices on a common time base.

Two different NTP servers may be defined. If the first server is not available the second server is used for trying to synchronize the time. Adjusting of the clock is performed in the interval selected (15min. up to 24h). If no time synchronization is desired, to both NTP servers the address 0.0.0.0 have to be assigned.

The setting of the addresses is done by means of the CB-Manager software. The NTP data is arranged in the register "Ethernet" of the device configuration.

Activation

To activate the time synchronization via NTP, the "Synchronisation RTC" must be checked by means of the checkbox.

| Gerät | Eingang | Mittelwerte | Grenzwert | Logikmodul | I/O 1-3 | I/O 4-7 |
|---------|-----------|-----------------|-----------|---------------|----------|---------|
| I/O 8,9 | I/O 10,11 | Betriebsstunden | Logger | Störschreiber | Ethernet | Anzeige |

Einstellungen

| | |
|---------------------|--|
| IP Adresse | 192.168.57.251 |
| Subnet-Maske | 255.255.252.0 |
| Gateway | 192.168.56.4 |
| NTP Server 1 | 192.168.56.56 |
| NTP Server 2 | 0.0.0.0 |
| Synchronisation RTC | <input checked="" type="checkbox"/> NTP Server |
| MODBUS TCP Port | 502 |
| MAC Adresse | 00 12 34 AE 00 07 |

6.4.5 TCP ports for data transmission

TCP ports

The TCP communication is done via so-called ports. The number of the used port allows determining the type of communication. As a standard Modbus/TCP communication is performed via TCP port 502, NTP uses port 123. However, the port for the Modbus/TCP telegrams may be modified. You may provide a unique port to each of the devices, e.g. 503, 504, 505 etc., for an easier analysis of the telegram traffic. The setting of the Modbus TCP port is done as shown above. Independent of these setting a communication via port 502 is always supported. The device allows at least 5 connections to different clients at the same time.

Firewall

Due to security reasons nowadays each network is protected by means of a firewall. When configuring the firewall you have to decide which communication is desired and which have to be blocked. The TCP port 502 for the Modbus/TCP communication normally is considered to be unsafe and is very often disabled. This may lead to a situation where no communication between networks (e.g. via Internet) is possible.

6.5 Installation of Profibus DP devices

The Profibus DP interface allows data exchange with a control system via Profibus-DP V0. The modular device model provides maximum protocol efficiency.

Required measured variables are determined during engineering and arranged as a fixed process image. The control system does not require any intelligence for the evaluation of the data (no tunneling protocol).

Bus parameterising facilitates simple and fast commissioning. On-site the following parameters can be set:

- Device address
- Accepting master parameterization (Check_User_Prm)
- Establishing communication to the master (Go_Online)
- Setting device address via master (Set_Slave_Addr_Supp)



For the assembly of the cyclical Profibus telegram the Modbus image is used. Via Modbus the same image can be used, but it's no longer possible to use it independently.

GSD parameterization

Typically the parameterization of the Profibus slave is done on the control system. During startup the *APLUS* adopts these settings. Doing so the parameterization of the input parameters (input system, transformer ratios etc.) as well as the assembly of the Modbus image will be overwritten. Other parts of the configuration, such as parameterization of I/O's or settings of limit values, remain unchanged.

All necessary informations for the parameterization are part of the DMF file. This one can be loaded from the Doku-CD supplied with the *APLUS*.

The assumption of the engineered parameters can be prevented by deactivating the Check_User_Prm flag. The parameterization locally set will not be changed this way.

Cyclical data exchange

The user can compose its own „station“ with all required quantities. Up to 60 measured quantities can be modularly concatenated. You may choose from instantaneous values of the system and imbalance analysis, mean-values of power quantities and freely selectable quantities as well as meter values.

Subsequent to the adoption of the parameterization, the *APLUS* is ready for the cyclical data exchange with the control system.

6.6 Protection against device data changing

Data stored in the device may be modified or reset via communication interface or via the keys on the device itself. To restrict these possibilities on-site, via CB-Manager the security system in the device can be activated (factory default: not activated). For the definition of these user rights in the software the input of an administrator login is required. The factory default is:

user: admin
password: admin

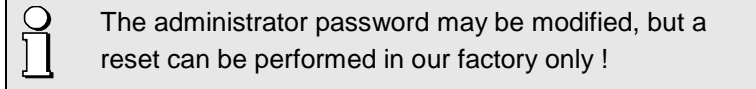

For one user via device and one user via interface (special login) the access to the following functions can individually be granted: Configuration of the device, modification of RTC parameters, modification of limit values, reset of min/max or meter values, alarm acknowledgment, display mode changing.

7. Operating the device

7.1 Operating elements

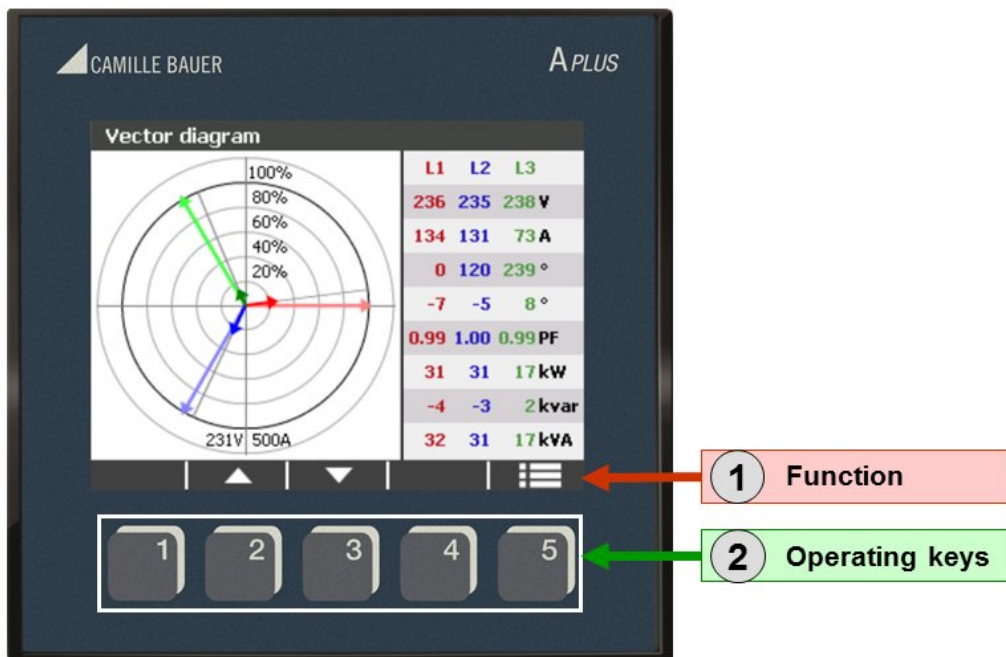

| | | |
|---|---|---|
| ① | The function assigned to the operating keys may change depending on the display information. The following functions are supported: | |
| | | Navigation to the left |
| | | Navigation to the top; Increase value during parameter setting |
| | | Navigation to the bottom; Decrease value during parameter setting |
| | | Navigation to the right |
| | | Menu selection, flashes if alarm is active |
| | | Settings menu |
| | | Alarm list display, flashes if alarm is active |
| | | Display of details, such as individual harmonic contents |
| | | Close the menu selection |
| | | Change value / setting |
| | | Accept value |
| | | Cancel |
| | | Activate a discrete parameter setting |
| | | Deactivate a discrete parameter setting |
| | | Close special mode (e.g. display of details) |
| | Reset minimum, maximum, meter content or alarm | |
| ② | Using the operating keys the functions shown in the display area will be executed. | |

7.2 Symbols used for display

Inside the measurement displays partly special symbols are used for closer describing the measurements. These symbols are described below:

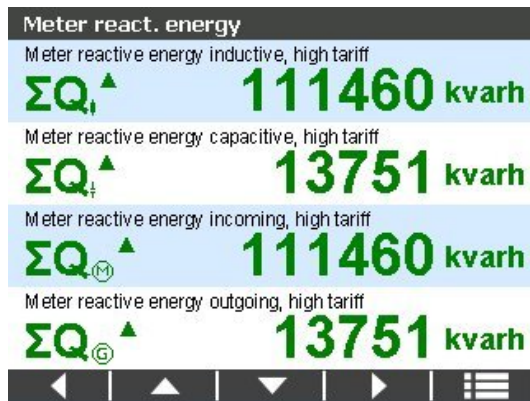

| Symbol | Meaning |
|--------|-------------------------------------|
| | Inductive load |
| | Capacitive load |
| | Energy demand (Motor operation) |
| | Energy supply (Generator operation) |
| | High tariff |
| | Low tariff |

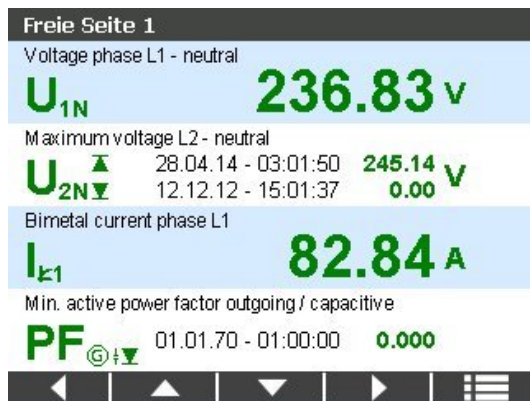

| Symbol | Meaning |
|--------|--------------------------------------|
| 1N | Phase reference phase 1 to neutral |
| | Minimum / maximum value |
| | Bimetal function (current) |
| | Quadrant: Energy supply / capacitive |

7.3 Display modes

The device supports two assemblies of measurement pages, which are arranged in form of a table (x/y matrix).

- **DEFAULT:** The factory default assembly of measurement pages
- **USER:** The freely defined measurement pages of the user (empty when delivered)

The display pages to use can be changed during operation. In combination with a possible automatic page change the user can define the displayable data and the behavior due to inactivity (no keys pressed by the user).

| Used display pages | Automatic page change | Behavior |
|--------------------|-----------------------|---|
| DEFAULT | None | The user can select images from the DEFAULT display pages. No automatic page change due to inactivity. |
| | Preferred page | |
| | Loop | |
| USER | None | The user can select images from the USER display pages. No automatic page change due to inactivity. |
| | Preferred page | The user can select images from the USER display pages. The preferred page is shown after a programmable inactivity time. |
| | Loop | A maximum of up to 20 pages from the customer pages (USER) are displayed endlessly one after the other. The interval time for the image change is programmable. |



The USER display pages can be activated only, if at least one customer display page has been defined !

The navigation within the measurement pages is done by means of the arrow keys:

| | |
|--|--|
| | One image to the left. |
| | Most left image of the next line is displayed. |
| | Most left image of the previous line is displayed. |
| | One image to the right. |

- ▶ The DEFAULT display matrices are shown in [Annex B](#)

7.4 Alarm handling

How alarms are handled is fixed during the configuration of the device. A detailed description of the alarming concept is here:

► [Monitoring und alarming](#)

7.4.1 Alarm state display on the device

The displayed states are the result of the state information analysis, defined by the user in the logic module.



A flashing menu symbol signals the occurrence of an alarm



The status display of the LED's is performed only, if the associated logic functions have been configured accordingly

7.4.2 Alarm text indication on the display

The displayable alarm list is the result of the state information analysis, defined by the user in the logic module. The number of entries in the alarm list depends on how many logic functions are used. If no function is used, no alarm list can be displayed.

If logic functions are defined, the alarm list may contain up to four entries, each with the states of the logic function and the possibly assigned follow-up action (relay or digital output).

| Logicmodul | |
|------------|---------|
| D1 | D OUT 6 |
| OFF | |
| D2 | D OUT 7 |
| ON | |
| D3 | REL 4 |
| OFF | |
| D4 | REL 5 |
| ON | |

Navigation icons: back, up, down, menu

To each alarm a state text for the active and the inactive state is assigned. The alarm list contains, depending on the present state, either the text for the active or the inactive alarm.

Display alarm list: followed by

7.4.3 Reset of alarms







If **alarm reset via display** is configured each alarm occurred needs to be reset individually to undo a possible follow-up action (e.g. the switching of a relay).

The subsequent sequence shows how to undo the follow-up action of an alarm:

1. Display alarm list (see 7.4.2)
2. Select entry using and
3. Select

7.5 Resetting measurements

The *APLUS* provides minimum and maximum values of different measured quantities as well as energy meters and operating hour counters. All of them may be reset during operation.









1. Select menu 
2. Select sub-menu 
3. Select entry using  and 
4. Select  to reset entry



Resetting of measurements may be protected via the security system implemented in the device. For further information see [protection against device data changing](#).

7.6 Configuration

A complete configuration of the *APLUS* is possible via CB-Manager software only using the configuration interface of the device. Via device only the parameters described below may be modified. To do so, a configuration menu is provided.

1. Select menu 
2. Select sub-menu 
3. Display the parameter to modify using the arrow keys
4. Select 
5. Perform the changing. Procedure depends on the quantity to modify:
 - Value setting: Change by means of the arrow keys
 - Select a list entry: Use  and  to select the desired entry
 - Selection: Use  or  for activating / deactivating the parameter
6. Use  to acknowledge or  to cancel

Setting time and date

All time information stored in the device is referenced to UTC¹⁾ (**U**niversal **T**ime **C**oordinated). For a better understanding the time/date information displayed on the display can be converted to local time by defining a time zone offset. This offset is added to the internal UTC time before the time information is displayed. Keep in mind that the offset may be variable if daylight saving time is used locally (see below).

Hint: *If time is set via CB-Manager software the difference between local time and UTC rather results from the local time settings of the PC than from the time zone offset configured via display. There may be a discrepancy.*

¹⁾ **UTC** (**U**niversal **T**ime **C**oordinated)

Sometimes UTC is called world time as well. The reference corresponds to the Greenwich Mean Time (GMT). The time zones of the world nowadays are all referenced with an offset to UTC. UTC time doesn't use time shifts, which may occur due to a change to daylight saving time.

Example: In Switzerland the CET (Central European Time) is valid, which has an offset of +1[h] to UTC. But during half of the year the CEST (Central European Summer Time) is used, which has an offset of +2[h] to the UTC time used in the device.

7.7 Data logger

The data logger offers a periodical acquisition of measurement data, such as recording load profiles, measurement fluctuations or meter readings as well as event triggered recordings of alarm states or disturbances. This storage medium used is an SD card, which allows almost unlimited recordings and an easy exchanging on-site.

The following recording types are supported:

| Logger | Triggered by... | Recording | Resettable |
|-------------------------------------|-----------------|---------------|------------|
| Power mean values | Interval t1 | ON / OFF | YES |
| Configurable mean values quantities | Interval t2 | ON / OFF | YES |
| Extreme values | Interval t3 | ON / OFF | YES |
| Meter readings | Calendar based | ON / OFF | YES |
| Disturbance recorder | Event | ON / OFF | YES |
| Alarm / event list | Event | always active | NO |
| Operator list | Event | always active | NO |

7.97.1 Activation of data logger recording

By configuring the different data loggers their state will not be changed. If it was active it remains active, if it was inactive it remains inactive. The activation / deactivation of a specific logger may be performed via PC software or via the [local programming menu](#). Only via PC software, respectively by using the corresponding commands via the configuration interface, contents of the individual logger can be reset.

Lists are exceptional, because they are always active to prevent manipulations. They record events in endless mode and can't be reset.

7.7.2 SD card

The device is supplied with a 2 GByte SD card, which allows long-term recordings. The device can be equipped with all other SD cards available.

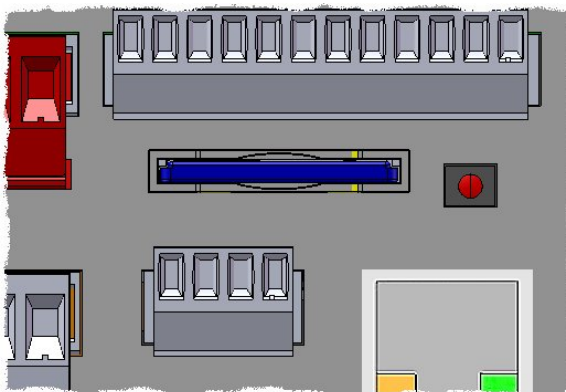

The red LED of the key located next to the SD card signals that the logger is active. During writing to the card the LED becomes dark for a short time.

To exchange an SD card the key must be pressed. As soon as the red LED becomes dark, the SD card can be removed and the new card inserted. Data can't be latched in the device. Therefore there is no recording for the time no card is present in the device.

| Status messages | Meaning |
|-----------------|--|
| NO CARD | The logger is active, but no SD card has been inserted. |
| CARDLOCK | The SD card inserted is write-protected. |
| CRD_FULL | For at least one of the logger parts, which are not used in endless mode, the assigned memory space is full. No more data can be recorded. |
| CARD_ERR | Faulty SD card. Possibly no more data will be recorded. |

7.7.3 Access to logger data

Only for device versions with Ethernet a direct access to the logger data via interface is possible. For all other versions you have to remove the SD card first and to access the recorded data using an internal or external card reader. The analysis of the data is performed using the supplied CB-Analyzer software.

7.7.4 Logger data analysis

The analysis of recorded logger data can be done using the supplied PC software CB-Analyzer. The software may also be downloaded free of charge from our homepage <http://www.camillebauer.com>.



The file "Read-me-first" on the Doku-CD provides all necessary information for the installation of the CB-Analyzer software and assistance for possible problems.

Functionality of the CB-Analyzer software

This .NET-based software facilitates the data acquisition and analysis of the optional data loggers and lists of SINEAX CAM and APLUS. The data read from the devices will be stored in a database. The program is capable of processing several devices simultaneously.

- ▶ Acquisition of logger and list data of several devices
- ▶ Storage of the data in a database (Access, SQLClient)
- ▶ Different analyzing options of the acquired data, also across devices
- ▶ Report generation in list or graphic format
- ▶ Selectable time range in the preparation of reports
- ▶ Export of report data to Excel or as an Acrobat PDF file

The CB-Analyzer software provides a comprehensive help facility, which describes in detail the operation of the software. Below a screen-shot is shown, which shows as an example the graphical analysis of the power demand of a factory over one week.

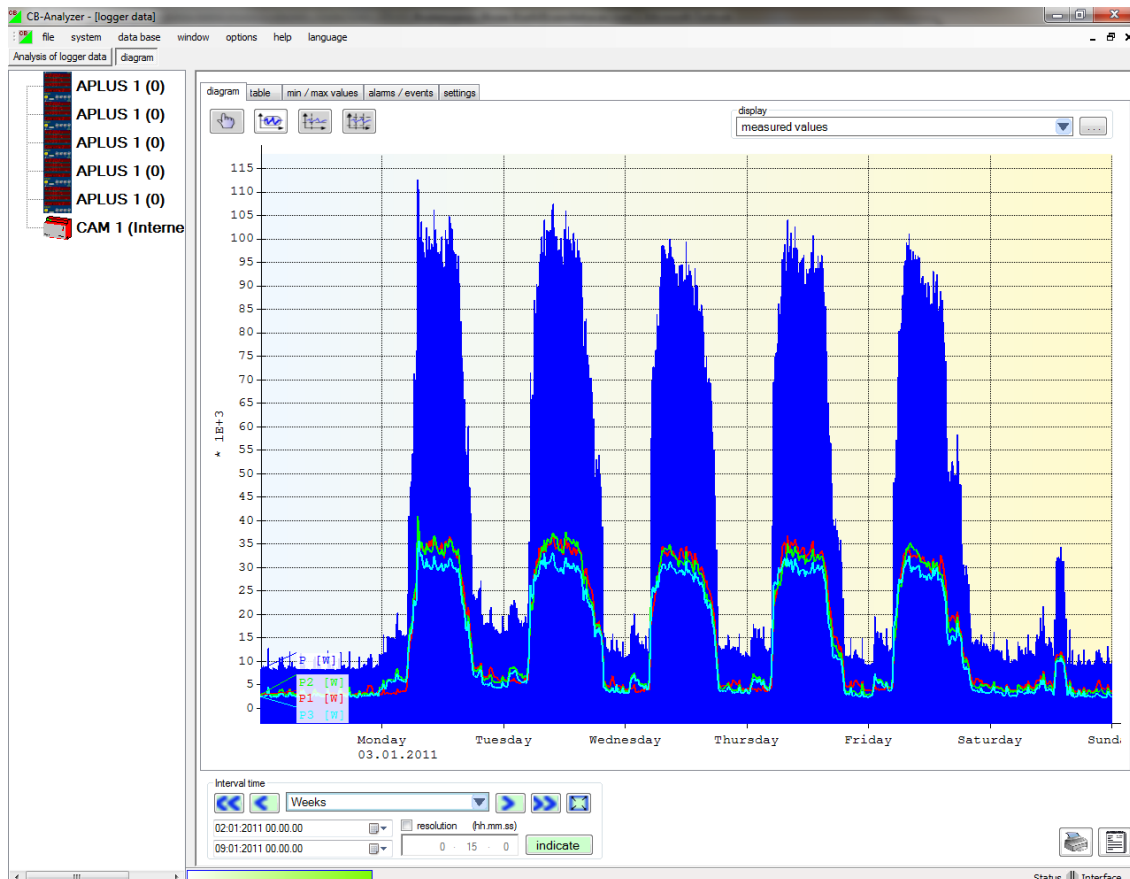

8. Service, maintenance and disposal

8.1 Protection of data integrity

The *APLUS* supports security mechanism, which serve to prevent manipulation or undesired modifications of device data.

► [Protection against device data modifications](#)

8.2 Calibration and new adjustment

Each device is adjusted and checked before delivery. The condition as supplied to the customer is measured and stored in electronic form.

The uncertainty of measurement devices may be altered during normal operation if, for example, the specified ambient conditions are not met. If desired, in our factory a calibration can be performed, including a new adjustment if necessary, to assure the accuracy of the device.

8.3 Cleaning

The display and the operating keys should be cleaned in regular intervals. Use a dry or slightly moist cloth for this.



Damage due to detergents

Detergents may not only affect the clearness of the display but also can damage the device. Therefore, do not use detergents.

8.4 Battery

The device contains a battery for buffering the internal clock. It cannot be changed by the user. The replacement can be done at the factory only.

8.5 Disposal

The product must be disposed in compliance with local regulations. This particularly applies to the built-in battery.

9. Technical data

Inputs

Nominal current: adjustable 1...5 A
Maximum: 7.5 A (sinusoidal)
Consumption: $\leq I^2 \times 0.01 \Omega$ per phase
Overload capacity: 10 A continuous
100 A, 10 x 1 s, interval 100 s

Current measurement via Rogowski coils
Range: 0...3000A, auto-ranging

See operating instructions of Rogowski coil
ACF3000_4/24 for further information

Nominal voltage: 57.7...400 V_{LN}, 100...693 V_{LL}
Maximum: 480 V_{LN}, 832 V_{LL} (sinusoidal)
Consumption: $\leq U^2 / 3 M\Omega$ per phase
Impedance: 3 M Ω per phase
Overload capacity: 480 V_{LN}, 832 V_{LL} continuous
600 V_{LN}, 1040 V_{LL}, 10 x 10 s, interval 10s
800 V_{LN}, 1386 V_{LL}, 10 x 1 s, interval 10s

Systems: Single phase
Split phase (2-phase system)
3-wire, balanced load
3-wire, unbalanced load
3-wire, unbalanced load, Aron connection
4-wire, balanced load
4-wire, unbalanced load
4-wire, unbalanced load, Open-Y

Nominal frequency: 45... 50 / 60 ...65Hz
Measurement TRMS: Up to the 63rd harmonic

Measurement uncertainty



Version with Rogowski current inputs

The additional uncertainty of the Rogowski coils ACF 3000_4/24 is not included in the following specifications: See operating instructions of Rogowski coil ACF3000_4/24

Reference conditions: Ambient 15...30°C,
(acc. IEC/EN 60688) sinusoidal input signals (form factor 1.1107)
Measurement over 8 cycles, no fixed system frequency for sampling,
PF=1, frequency 50...60Hz

Voltage, current: $\pm (0.08\% MV + 0.02\% MR)$ ^{1) 2)}
Power: $\pm (0.16\% MV + 0.04\% MR)$ ^{3) 2)}
Power factor: $\pm 0.1^\circ$ ⁴⁾
Frequency: ± 0.01 Hz
Imbalance U, I: $\pm 0.5\%$
Harmonics: $\pm 0.5\%$
THD Voltage: $\pm 0.5\%$
TDD Current: $\pm 0.5\%$
Active energy: Class 0.5S, EN 62053-22
Reactive energy: Class 2, EN 62053-23

Measurement with fixed system frequency:

General \pm Basic uncertainty x (F_{konfig}-F_{ist}) [Hz] x 10
Imbalance U $\pm 1.5\%$ up to ± 0.5 Hz
Harmonics $\pm 1.5\%$ up to ± 0.5 Hz
THD, TDD $\pm 2.0\%$ up to ± 0.5 Hz

¹⁾ MV: Measured value, MR: measurement range (maximum)

²⁾ Additional uncertainty of 0.1% MV if neutral wire not connected (3-wire connections)

³⁾ MR: maximum voltage x maximum current

⁴⁾ Additional uncertainty of 0.1° if neutral wire not connected (3-wire connections)

Zero suppression, range limitations

The measurement of specific quantities is related to a pre-condition which must be fulfilled, that the corresponding value can be determined and sent via interface or displayed. If this condition is not fulfilled, a default value is used for the measurement.

| Quantity | Condition | Default |
|--------------------|--|---------|
| Voltage | $U_x < 1\% U_{x_{max}}$ | 0.00 |
| Current | $I_x < 0,1\% I_{x_{max}}$ | 0.00 |
| PF | $S_x < 1\% S_{x_{max}}$ | 1.00 |
| QF, LF, $\tan\phi$ | $S_x < 1\% S_{x_{max}}$ | 0.00 |
| Frequency | voltage and/or current input too low ¹⁾ | 44.90 |
| Voltage unbalance | $U_x < 5\% U_{x_{max}}$ | 0.00 |
| Current unbalance | mean value of phase currents $< 5\% I_{x_{max}}$ | 0.00 |
| Phase angle | at least one voltage $U_x < 5\% U_{x_{max}}$ | 120° |
| Harmonics U, THD-U | fundamental $< 5\% U_{x_{max}}$ | 0.00 |

¹⁾ specific level depends on the device configuration

Power supply

via plug-in terminal

Nominal voltage:

100...230V AC $\pm 15\%$, 50...400Hz

24...230V DC $\pm 15\%$

Consumption:

$\leq 7...10$ VA, depending on the device hardware used

I/O interface

Available inputs and outputs

| | |
|------------------------|---|
| Basic unit | - 1 relay output, changeover contact - 1 digital output (fixed) - 1 digital input (fixed) |
| I/O extension 1 | - 2 relay outputs, changeover contact - 4 bipolar analog outputs - 2 digital inputs/outputs, each configurable as input or output |
| I/O extension 2 | - 2 relay outputs, changeover contact - 6 digital inputs/outputs, each configurable as input or output |

Analog outputs

| | |
|-------------------|--|
| | via plug-in terminals, galvanically isolated |
| Linearization: | Linear, quadratic, kinked |
| Range: | ± 20 mA (24 mA max.), bipolar |
| Uncertainty: | $\pm 0.2\%$ of 20 mA |
| Burden: | $\leq 500 \Omega$ (max. 10 V / 20 mA) |
| Burden influence: | $\leq 0.2\%$ |
| Residual ripple: | $\leq 0.4\%$ |
| Response time: | 60...100ms (for 2 cycles averaging time of RMS values) |

Relays

| | |
|----------------|---|
| | via plug-in terminals |
| Contact: | changeover contact, bistabil |
| Load capacity: | 250 V AC, 2 A, 500 VA 30 V DC, 2 A, 60 W |

Digital inputs/outputs via plug-in terminals

Digital inputs (acc. EN 61 131-2 DC 24 V type 3):

| | |
|-----------------|--------------------------|
| Nominal voltage | 12 / 24 V DC (30 V max.) |
| Logical ZERO | - 3 up to + 5 V |
| Logical ONE | 8 up to 30 V |

Digital outputs (partly acc. EN 61 131-2):

| | |
|-----------------|-------------------------------|
| Nominal voltage | 12 / 24 V DC (30 V max.) |
| Nominal current | 50 mA (60 mA max.) |
| Load capability | 400 Ω ... 1 M Ω |

Interfaces

Modbus/RTU X4 / X8

| | |
|-------------------------|---|
| | via plug-in terminals |
| Protocol: | Modbus RTU |
| Physics: | RS-485, max. 1200m (4000 ft) |
| Baud rate: | 2'400, 4'800, 9'600, 19'200, 38'400, 57'600, 115'200 Baud |
| Number of participants: | ≤ 32 |

Profibus X8

| | |
|------------|--|
| | via 9-pin D-sub socket |
| Protocol: | Profibus DP |
| Physics: | RS-485, 100...1200m (depending on baud rate and cable type used) |
| Baud rate: | Automatic baud rate recognition (9.6kBit/s ... 12MBit/s) |
| Address: | 0...125 (default: 126) |

Ethernet X4

| | |
|-----------|---|
| | via RJ45 connector |
| Protocol: | Modbus/TCP, NTP |
| Physics: | Ethernet 100BaseTX |
| Mode: | 10/100 MBit/s, full/half duplex, auto-negotiation |

Internal clock (RTC)

| | |
|------------------|-------------------------------------|
| Uncertainty: | ± 2 minutes / month (15 up to 30°C) |
| Synchronization: | via Synchronization pulse |
| Running reserve: | > 10 years |

Ambient conditions, general information

| | |
|---------------------------------|---|
| Operating temperature: | -10 up to <u>15 up to 30</u> up to + 55°C |
| Storage temperature: | -25 up to + 70°C |
| Temperature influence: | 0.5 x measurement uncertainty per 10 K |
| Long term drift: | 0.2 x measurement uncertainty per year |
| Others: | Usage group II (EN 60 688) |
| Relative humidity: | < 95% no condensation |
| Altitude: | ≤ 2000 m max. |
| Device to be used indoor only ! | |

Mechanical attributes

| | |
|---------------------|--|
| Orientation: | Any |
| Housing material: | Polycarbonat (Makrolon) |
| Flammability class: | V-0 acc. UL94, non-dripping, free of halogen |
| Weight: | 500 g |
| Dimensions: | Dimensional drawings |

Vibration withstand (test according to DIN EN 60 068-2-6)

| | |
|-------------------|--|
| Acceleration: | ± 5 g |
| Frequency range: | 10 ... 150 ... 10 Hz, rate of frequency sweep: 1 octave/minute |
| Number of cycles: | 10 in each of the 3 axes |

Security

The current inputs are galvanically isolated from each other

| | |
|----------------------------------|---|
| Protection class: | II (protective insulation, voltage inputs via protective impedance) |
| Pollution degree: | 2 |
| Protection: | IP64 (front), IP40 (housing), IP20 (terminals) |
| Measurement category: | CAT III, CATII (relays) |
| Rated voltage (versus earth): | power supply: 265 V AC Relays: 250 V AC I/O's: 30 V DC |
| Test voltages: | DC, 1 min., acc. IEC/EN 61010-1 7504V DC, power supply versus inputs U, I 5008V DC, power supply versus bus, I/O's, relays 6030V DC, inputs U versus inputs I 4690V DC, inputs U after protective impedance versus bus, I/O's, relays 7504V DC, inputs U versus relays 7504V DC, inputs I versus bus, I/O's, relays 6030V DC, inputs I versus inputs I 3130V DC, relay versus relay, bus, I/O's |

Applied regulations, standards and directives

| | |
|-------------------------------------|--|
| IEC/EN 61 010-1 | Safety regulations for electrical measuring, control and laboratory equipment |
| IEC/EN 60 688 | Electrical measuring transducers for converting AC electrical variables into analog or digital signals |
| DIN 40 110 | AC quantities |
| IEC/EN 60 068-2-1/ -2/-3/-6/-27: | Ambient tests -1 Cold, -2 Dry heat, -3 Damp heat, -6 Vibration, -27 Shock |
| IEC/EN 60 529 | Protection type by case |
| IEC/EN 61 000-6-2/ 61 000-6-4: | Electromagnetic compatibility (EMC) Generic standard for industrial environment |
| IEC/EN 61 131-2 | Programmable controllers - equipment, requirements and tests (digital inputs/outputs 12/24V DC) |
| IEC/EN 61 326 | Electrical equipment for measurement, control and laboratory use - EMC requirements |
| IEC/EN 62 053-31 | Pulse output devices for electromechanical and electronic meters (S0 output) |
| UL94 | Tests for flammability of plastic materials for parts in devices and appliances |
| 2002/95/EG (RoHS) | EC directive on the restriction of the use of certain hazardous substances |

Warning

This is a class A product. In a domestic environment this product may cause radio interference in which case the user may be required to take adequate measures.

This device complies with part 15 of the FCC:

Operation is subject to the following two conditions: (1) This device may not cause harmful interference, and (2) this device must accept any interference received, including interference that may cause undesired operation.

This Class A digital apparatus complies with Canadian ICES-0003.

10. Dimensional drawings

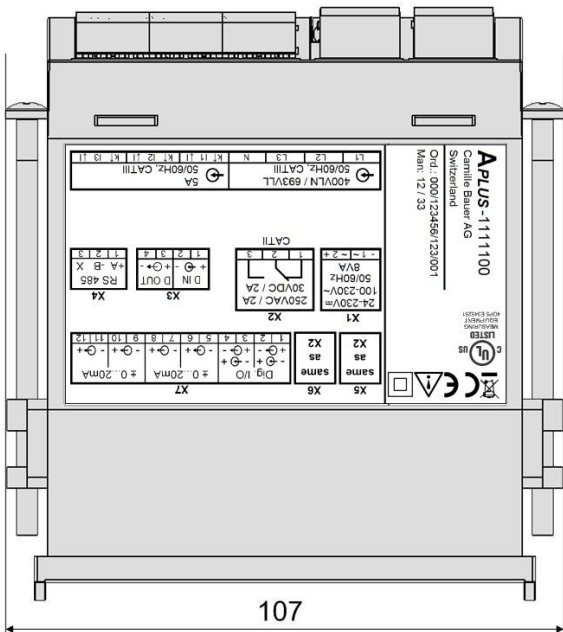
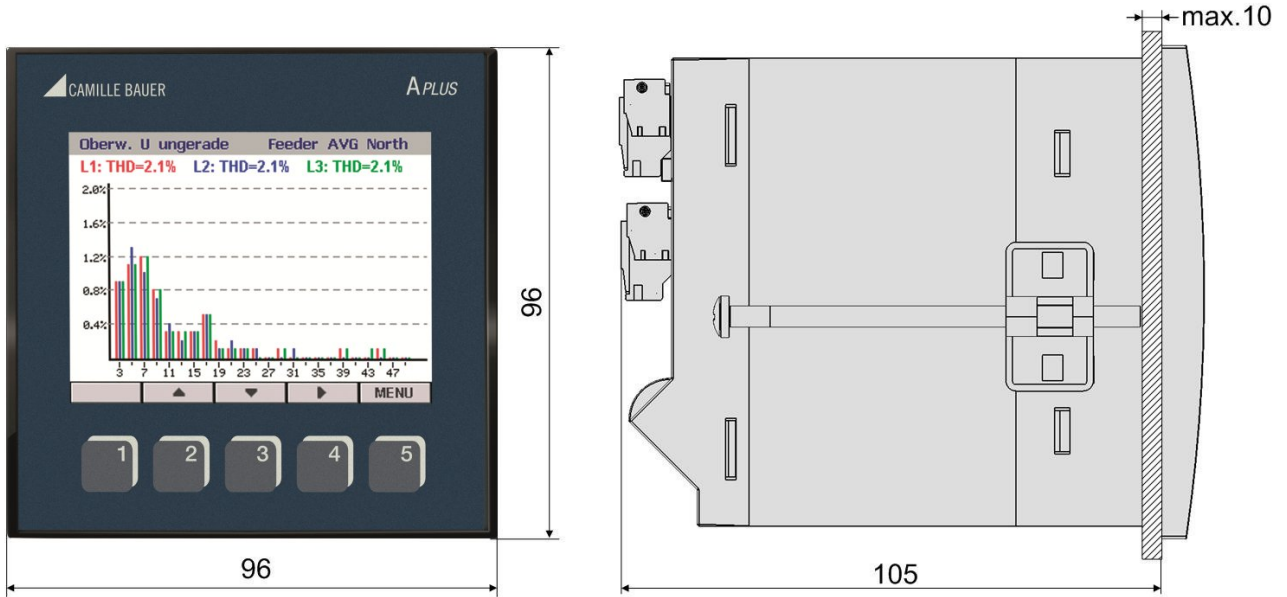

APLUS with display

Annex

A Description of measured quantities

Used abbreviations

| | |
|-------|---|
| 1L | Single phase system |
| 2L | Split phase; system with 2 phases and centre tap |
| 3Lb | 3-wire system with balanced load |
| 3Lu | 3-wire system with unbalanced load |
| 3Lu.A | 3-wire system with unbalanced load, Aron connection (only 2 currents connected) |
| 4Lb | 4-wire system with balanced load |
| 4Lu | 4-wire system with unbalanced load |
| 4Lu.O | 4-wire system with unbalanced load, Open-Y (reduced voltage connection) |

A1 Basic measurements

These measured quantities are determined using the configured measurement time (2...1024 cycles, in steps of 2 cycles). If a measurement is available depends on the selected system.

Depending on the measured quantity also minimum and maximum values are determined and non-volatile stored with timestamp. These values may be reset by the user via the display unit or via the configuration interface, see [resetting of measurements](#).

| Measurement | present | max | min | 1L | 2L | 3Lb | 3Lu | 3Lu.A | 4Lb | 4Lu.O | 4Lu |
|---|---------|-----|-----|----|----|-----|-----|-------|-----|-------|-----|
| Voltage U | • | • | • | ↘ | ↘ | | | | ↘ | | |
| Voltage U _{1N} | • | • | • | | ↘ | | | | | √ | √ |
| Voltage U _{2N} | • | • | • | | ↘ | | | | | √ | √ |
| Voltage U _{3N} | • | • | • | | | | | | | √ | √ |
| Voltage U ₁₂ | • | • | • | | | √ | √ | √ | | √ | √ |
| Voltage U ₂₃ | • | • | • | | | √ | √ | √ | | √ | √ |
| Voltage U ₃₁ | • | • | • | | | √ | √ | √ | | √ | √ |
| Zero displacement voltage U _{NE} | • | • | | | | | | | | | √ |
| Current I | • | • | | √ | | √ | | | √ | | |
| Current I1 | • | • | | | √ | | √ | √ | | √ | √ |
| Current I2 | • | • | | | √ | | √ | √ | | √ | √ |
| Current I3 | • | • | | | | | √ | √ | | √ | √ |
| Bimetal current 1...60min. IB | • | • | | √ | | √ | | | √ | | |
| Bimetal current 1...60min. IB1 | • | • | | | √ | | √ | √ | | √ | √ |
| Bimetal current 1...60min. IB2 | • | • | | | √ | | √ | √ | | √ | √ |
| Bimetal current 1...60min. IB3 | • | • | | | | | √ | √ | | √ | √ |
| Neutral current I _N | • | • | | | | | | | | √ | √ |
| Active power P | • | • | | √ | √ | √ | √ | √ | √ | √ | √ |
| Active power P1 | • | • | | | √ | | | | | √ | √ |
| Active power P2 | • | • | | | √ | | | | | √ | √ |
| Active power P3 | • | • | | | | | | | | √ | √ |
| Reactive power Q | • | • | | √ | √ | √ | √ | √ | √ | √ | √ |
| Reactive power Q1 | • | • | | | √ | | | | | √ | √ |
| Reactive power Q2 | • | • | | | √ | | | | | √ | √ |
| Reactive power Q3 | • | • | | | | | | | | √ | √ |
| Apparent power S | • | • | | √ | √ | √ | √ | √ | √ | √ | √ |
| Apparent power S1 | • | • | | | √ | | | | | √ | √ |
| Apparent power S2 | • | • | | | √ | | | | | √ | √ |
| Apparent power S3 | • | • | | | | | | | | √ | √ |
| Frequency F | • | • | • | √ | √ | √ | √ | √ | √ | √ | √ |

| Measurement | present | max | min | 1L | 2L | 3Lb | 3Lu | 3Lu.A | 4Lb | 4Lu.O | 4Lu |
|--|---------|-----|-----|----|----|-----|-----|-------|-----|-------|-----|
| Power factor PF | • | | | √ | √ | √ | √ | √ | √ | √ | √ |
| Power factor PF1 | • | | | | √ | | | | | √ | √ |
| Power factor PF2 | • | | | | √ | | | | | √ | √ |
| Power factor PF3 | • | | | | | | | | | √ | √ |
| PF incoming inductive | | | • | √ | √ | √ | √ | √ | √ | √ | √ |
| PF incoming capacitive | | | • | √ | √ | √ | √ | √ | √ | √ | √ |
| PF outgoing inductive | | | • | √ | √ | √ | √ | √ | √ | √ | √ |
| PF outgoing capacitive | | | • | √ | √ | √ | √ | √ | √ | √ | √ |
| Reactive power factor QF | • | | | √ | √ | √ | √ | √ | √ | √ | √ |
| Reactive power factor QF1 | • | | | | √ | | | | | √ | √ |
| Reactive power factor QF2 | • | | | | √ | | | | | √ | √ |
| Reactive power factor QF3 | • | | | | | | | | | √ | √ |
| Load factor LF | • | | | √ | √ | √ | √ | √ | √ | √ | √ |
| Load factor LF1 | • | | | | √ | | | | | √ | √ |
| Load factor LF2 | • | | | | √ | | | | | √ | √ |
| Load factor LF3 | • | | | | | | | | | √ | √ |
| $U_{\text{mean}}=(U1N+U2N)/2$ | • | | | | √ | | | | | | |
| $U_{\text{mean}}=(U1N+U2N+U3N)/3$ | • | | | | | | | | | √ | √ |
| $U_{\text{mean}}=(U12+U23+U31)/3$ | • | | | | | | √ | √ | | | |
| $I_{\text{mean}}=(I1+I2)/2$ | • | | | | √ | | | | | | |
| $I_{\text{mean}}=(I1+I2+I3)/3$ | • | | | | | | √ | √ | | √ | √ |
| Phase angle between U1 and U2 | • | | | | | √ | √ | √ | | √ | √ |
| Phase angle between U2 and U3 | • | | | | | √ | √ | √ | | √ | √ |
| Phase angle between U3 and U1 | • | | | | | √ | √ | √ | | √ | √ |
| Maximum $\Delta U \llcorner U_m$ ¹⁾ | • | • | | | | √ | √ | √ | | | √ |
| Maximum $\Delta I \llcorner I_m$ ²⁾ | • | • | | | | | √ | | | √ | √ |
| IMS, Average current with sign of P | • | | | | | | √ | √ | | √ | √ |

¹⁾ maximum deviation from the mean value of all voltages ([see A3](#))

²⁾ maximum deviation from the mean value of all currents ([see A3](#))

Power factors

The **power factor PF** gives the relation between active and apparent power. If there are no harmonics present in the system, it corresponds to the $\cos\varphi$ (see also [Reactive power](#)). The PF has a range of $-1 \dots 0 \dots +1$, where the sign gives the direction of energy flow.

The **load factor LF** is a quantity derived from the PF, which allows making a statement about the load type. Only this way it's possible to measure a range like 0.5 capacitive ... 1 ... 0.5 inductive in a non-ambiguous way.

The **reactive power factor QF** gives the relation between reactive and apparent power.

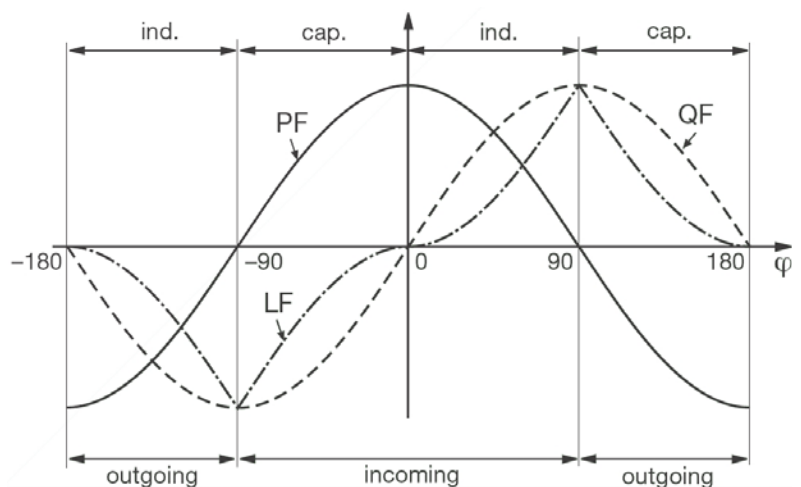

Zero displacement voltage U_{NE}

Starting from the generating system with star point E (which is normally earthed), the star point (N) on load side is shifted in case of unbalanced load. The zero displacement voltage between E and N may be determined by a vectorial addition of the voltage vectors of the three phases:

$$U_{NE} = - (U_{1N} + U_{2N} + U_{3N}) / 3$$

A displacement voltage may also occur due to harmonics of order 3, 9, 15, 21 etc., because the dedicated currents add in the neutral wire.

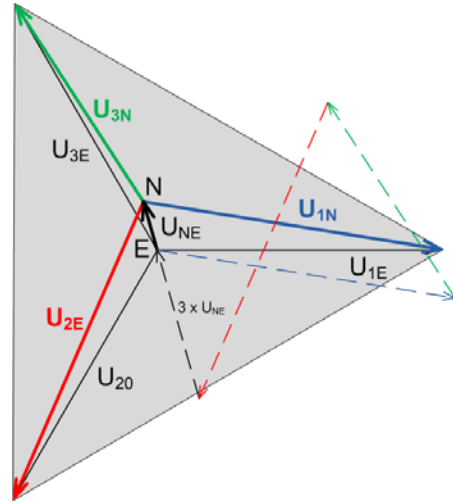

Earth fault monitoring in IT systems

Via the determination of the zero displacement voltage it's possible to detect a first earth fault in an unearthed IT system. To do so, the device is configured for measurement in a 4-wire system with unbalanced load and the neutral connector is connected to earth. In case of a single phase earth fault there is a resulting zero displacement voltage of $U_{LL} / \sqrt{3}$. The alarming may be done e.g. by means of a relay output.

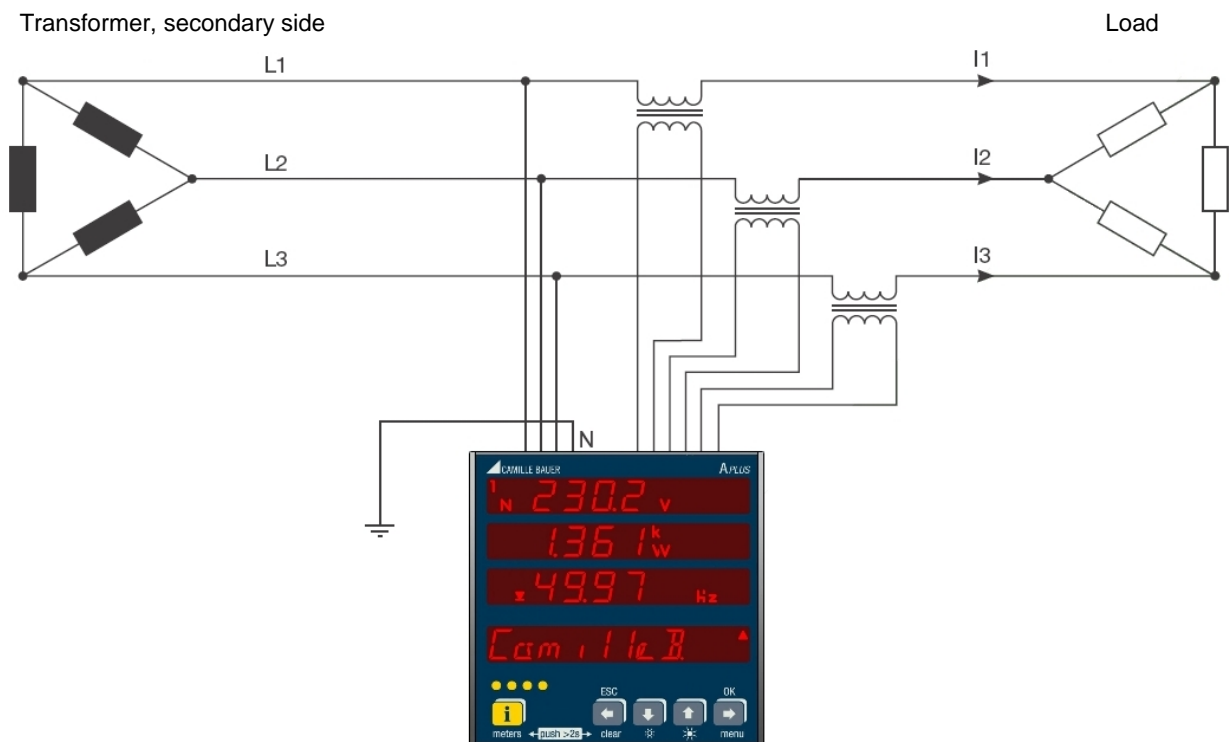

Because in case of a fault the voltage triangle formed by the three phases does not change the voltage and current measurements as well as the system power values will be still measured and displayed correctly. Also the meters carry on to work as expected.

The method is suited to detect a fault condition during normal operation. A declination of the isolation resistance may not be detected this way. This should be measured during a periodical control of the system using a mobile system.

Another possibility to analyze fault conditions in a grid offers the method of the [symmetrical components](#) as described in A3.

A2 Harmonic analysis

| Measurement | present | max | 1L | 2L | 3Lb | 3Lu | 3Lu.A | 4Lb | 4Lu.O | 4Lu |
|--|---------|-----|----|----|-----|-----|-------|-----|-------|-----|
| THD Voltage U1N/U | ● | ● | √ | √ | | | | √ | √ | √ |
| THD Voltage U2N | ● | ● | √ | √ | | | | | √ | √ |
| THD Voltage U3N | ● | ● | | | | | | | √ | √ |
| THD Voltage U12 | ● | ● | | | √ | √ | √ | | | |
| THD Voltage U23 | ● | ● | | | √ | √ | √ | | | |
| THD Voltage U31 | ● | ● | | | √ | √ | √ | | | |
| TDD Current I1/I | ● | ● | √ | √ | √ | √ | √ | √ | √ | √ |
| TDD Current I2 | ● | ● | | √ | | √ | √ | | √ | √ |
| TDD Current I3 | ● | ● | | | | √ | √ | | √ | √ |
| Harmonic contents 2nd...50th U1N/U | ● | ● | √ | √ | | | | √ | √ | √ |
| Harmonic contents 2nd...50th U2N | ● | ● | | √ | | | | | √ | √ |
| Harmonic contents 2nd...50th U3N | ● | ● | | | | | | | √ | √ |
| Harmonic contents 2nd...50th U12 | ● | ● | | | √ | √ | √ | | | |
| Harmonic contents 2nd...50th U23 | ● | ● | | | √ | √ | √ | | | |
| Harmonic contents 2nd...50th 2.-50. U31 | ● | ● | | | √ | √ | √ | | | |
| Harmonic contents 2nd...50th 2.-50. I1/I | ● | ● | √ | √ | √ | √ | √ | √ | √ | √ |
| Harmonic contents 2nd...50th 2.-50. I2 | ● | ● | | √ | | √ | √ | | √ | √ |
| Harmonic contents 2nd...50th 2.-50. I3 | ● | ● | | | | √ | √ | | √ | √ |

Harmonics

Harmonics are multiple of the fundamental resp. system frequency. They arise if non-linear loads, such as RPM regulated drives, rectifiers, thyristor controlled systems or fluorescent lamps are present in the power system. Thus undesired side effects occur, such as additional thermal stress to operational resources or electrical mains, which lead to an advanced aging or even damage. Also the reliability of sensitive loads can be affected and unexplainable disturbances may occur. In industrial networks the image of the harmonics gives good information about the kind of loads connected. See also:

► [Increase of reactive power due to harmonic currents](#)

TDD (Total Demand Distortion)

In the *APLUS* the complete harmonic content of the currents is shown as Total Demand Distortion, briefly TDD. This value is scaled to the rated current resp. rated power. Only this way it's possible to estimate the influence of the current harmonics on the connected equipment correctly.

Maximum values

The maximum values of the harmonic analysis arise from the monitoring of THD and TDD. The maximum values of individual harmonics are not monitored separately, but are stored if a maximum value of THD or TDD is detected. The image of the maximum harmonics therefore always corresponds to the dedicated THD resp. TDD.



The accuracy of the harmonic analysis depends strongly on the quality of the current and voltage transformers possibly used. In the harmonics range transformers normally change both, the amplitude and the phase of the signals to measure. It's valid: The higher the frequency of the harmonic, the higher its damping resp. phase shift.

A3 System imbalance

| Measured quantity | present | max | min | 1L | 2L | 3Lb | 3Lu | 3Lu-A | 4Lb | 4Lu.O | 4Lu |
|----------------------------|---------|-----|-----|----|----|-----|-----|-------|-----|-------|-----|
| UR1: Positive sequence [V] | • | | | | | √ | √ | √ | | | √ |
| UR2: Negative sequence [V] | • | | | | | √ | √ | √ | | | √ |
| U0: Zero sequence [V] | • | | | | | | | | | | √ |
| U: Imbalance UR2/UR1 | • | • | | | | √ | √ | √ | | | √ |
| U: Imbalance U0/UR1 | • | • | | | | | | | | | √ |
| IR1: Positive sequence [A] | • | | | | | | √ | | | √ | √ |
| IR2: Negative sequence [A] | • | | | | | | √ | | | √ | √ |
| I0: Zero sequence [A] | • | | | | | | √ | | | √ | √ |
| I: Imbalance IR2/IR1 | • | • | | | | | √ | | | √ | √ |
| I: Imbalance I0/IR1 | • | • | | | | | √ | | | √ | √ |

 Available via interface only

Imbalance in three-phase systems may occur due to single-phase loads, but also due to failures, such as e.g. the blowing of a fuse, an earth fault, a phase failure or an isolation defect. Also harmonics of the 3rd, 9th, 15th, 21st etc. order, which add in the neutral wire, may lead to imbalance. Operating resources dimensioned to rated values, such as three-phase generators, transformers or motors on load side, may be excessively stressed by imbalance. So a shorter life cycle, a damage or failure due to thermal stress can result. Therefore monitoring imbalance helps to reduce the costs for maintenance and extends the undisturbed operating time of the used resources.

Imbalance or unbalanced load relays use different measurement principles. One of them is the approach of the symmetrical components, the other one calculates the maximum deviation from the mean-value of the three phase values. The results of these methods are not equal and don't have the same intention. Both of these principles are implemented in the *APLUS*.

Symmetrical components (acc. Fortescue)

The imbalance calculation method by means of the symmetrical components is ambitious and intensive to calculate. The results may be used for disturbance analysis and for protection purposes in three-phase systems. The real existing system is divided in symmetrical system parts: A positive sequence, a negative sequence and (for systems with neutral conductor) a zero sequence system. The approach is easiest to understand for rotating machines. The positive sequence represents a positive rotating field, the negative sequence a negative (braking) rotating field with opposite sense of direction. Therefore the negative sequence prevents that the machine can generate the full turning moment. For e.g. generators the maximum permissible current imbalance is typically limited to a value of 8...12%.

Maximum deviation from the mean value

The calculation of the maximum deviation from the mean value of the phase currents resp. phase voltages gives the information if a grid or substation is imbalanced loaded. The results are independent of rated values and the present load situation. So a more symmetrical system can be aspired, e.g. by changing loads from one phase to another.

Also failure detection is possible. The capacitors used in compensation systems are wear parts, which fail quite often and then have to be replaced. When using three phase power capacitors all phases will be compensated equally which leads to almost identical currents flowing through the capacitors, if the system load is comparable. By monitoring the current imbalance it's then possible to estimate if a capacitor failure is present.

The maximum deviations are calculated in the same steps as the instantaneous values and therefore are arranged there ([see A1](#)).

A4 Reactive power

| Measured quantity | pres. | max | min | 1L | 2L | 3Lb | 3Lu | 3Lu.A | 4Lb | 4Lu.O | 4Lu |
|--|-------|-----|-----|----|----|-----|-----|-------|-----|-------|-----|
| Distortion reactive power D | • | • | | √ | √ | √ | √ | √ | √ | √ | √ |
| Distortion reactive power D1 | • | • | | | √ | | | | | √ | √ |
| Distortion reactive power D2 | • | • | | | √ | | | | | √ | √ |
| Distortion reactive power D3 | • | • | | | | | | | | √ | √ |
| Fundamental reactive power QG | • | • | | √ | √ | √ | √ | √ | √ | √ | √ |
| Fundamental reactive power QG1 | • | • | | | √ | | | | | √ | √ |
| Fundamental reactive power QG2 | • | • | | | √ | | | | | √ | √ |
| Fundamental reactive power QG3 | • | • | | | | | | | | √ | √ |
| cosφ of fundamental | • | | • | √ | √ | √ | √ | √ | √ | √ | √ |
| cosφ of fundamental L1 | • | | • | | √ | | | | | √ | √ |
| cosφ of fundamental L2 | • | | • | | √ | | | | | √ | √ |
| cosφ of fundamental L3 | • | | • | | | | | | | √ | √ |
| cosφ of fundamental, incoming inductive | | | • | √ | √ | √ | √ | √ | √ | √ | √ |
| cosφ of fundamental, incoming capacitive | | | • | √ | √ | √ | √ | √ | √ | √ | √ |
| cosφ of fundamental, outgoing inductive | | | • | √ | √ | √ | √ | √ | √ | √ | √ |
| cosφ of fundamental, outgoing capacitive | | | • | √ | √ | √ | √ | √ | √ | √ | √ |
| tanφ of fundamental | • | | | √ | √ | √ | √ | √ | √ | √ | √ |
| tanφ of fundamental L1 | • | | | | √ | | | | | √ | √ |
| tanφ of fundamental L2 | • | | | | √ | | | | | √ | √ |
| tanφ of fundamental L3 | • | | | | | | | | | √ | √ |

Available via interface only

Most of the loads consume a combination of ohmic and inductive current from the power system. Reactive power arises by means of the inductive load. But the number of non-linear loads, such as RPM regulated drives, rectifiers, thyristor controlled systems or fluorescent lamps, is increasing. They cause non-sinusoidal AC currents, which may be represented as a sum of harmonics. Thus the reactive power to transmit increases and leads to higher transmission losses and higher energy costs. This part of the reactive power is called distortion reactive power.

Normally reactive power is unwanted, because there is no usable active component in it. Because the transmission of reactive power over long distances is uneconomic, it makes sense to install compensation systems close to the consumers. So transmission capacities may be used better and losses and voltage drops by means of harmonic currents can be avoided.

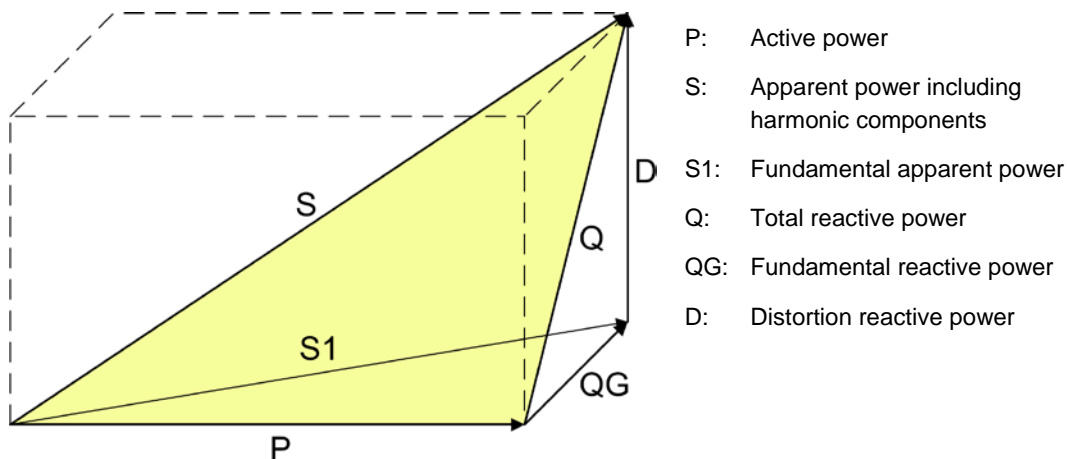

The reactive power may be divided in a fundamental and a distortion component. Only the fundamental reactive power may be compensated directly by means of the classical capacitive method. The distortion components have to be combated using inductors or active harmonic conditioners.

The *APLUS* reports a **load factor PF** which is the relation between active power P and apparent power S , including all possibly existing harmonic parts. This factor is often called $\cos\varphi$, which is only partly correct. The PF corresponds to the **cos φ** only, if there is no harmonic content present in the system. So the $\cos\varphi$ represents the relation between the active power P and the fundamental apparent power S_1 .

Also calculated is the **tan φ** , which is especially known as a target quantity for the reactive power compensative using capacitors. It corresponds to the relation of the fundamental reactive power Q_G and the active power P . Here intentionally the fundamental reactive power is used for the calculation, because this is the only component which may be directly compensated via capacitors.

A5 Mean values and trend

| Measured quantity | Present | Trend | max | min | History |
|---|---------|-------|-----|-----|---------|
| Active power incoming 1s...60min. ¹⁾ | • | • | • | • | 5 |
| Active power outgoing 1s...60min. ¹⁾ | • | • | • | • | 5 |
| Reactive power incoming 1s...60min. ¹⁾ | • | • | • | • | 5 |
| Reactive power outgoing 1s...60min. ¹⁾ | • | • | • | • | 5 |
| Reactive power inductive 1s...60min. ¹⁾ | • | • | • | • | 5 |
| Reactive power capacitive 1s...60min. ¹⁾ | • | • | • | • | 5 |
| Apparent power 1s...60min. ¹⁾ | • | • | • | • | 5 |
| Mean value quantity 1 1s...60min. ²⁾ | • | • | • | • | 1 |
| Mean value quantity 2 1s...60min. ²⁾ | • | • | • | • | 1 |
| Mean value quantity 3 1s...60min. ²⁾ | • | • | • | • | 1 |
| Mean value quantity 4 1s...60min. ²⁾ | • | • | • | • | 1 |
| Mean value quantity 5 1s...60min. ²⁾ | • | • | • | • | 1 |
| Mean value quantity 6 1s...60min. ²⁾ | • | • | • | • | 1 |
| Mean value quantity 7 1s...60min. ²⁾ | • | • | • | • | 1 |
| Mean value quantity 8 1s...60min. ²⁾ | • | • | • | • | 1 |
| Mean value quantity 9 1s...60min. ²⁾ | • | • | • | • | 1 |
| Mean value quantity 10 1s...60min. ²⁾ | • | • | • | • | 1 |
| Mean value quantity 11 1s...60min. ²⁾ | • | • | • | • | 1 |
| Mean value quantity 12 1s...60min. ²⁾ | • | • | • | • | 1 |

 Available via interface only ¹⁾ Interval time t1 ²⁾ Interval time t2

The device calculates automatically the mean values of all system power quantities. In addition up to 12 further mean value quantities can be freely selected.

Calculating the mean-values

The mean value calculation is performed via integration of the measured instantaneous values over a configurable averaging interval. The interval time may be selected in the range from one second up to one hour. Possible interim values are set the way that a multiple of it is equal to a minute or an hour. Mean values of power quantities (interval time t1) and free quantities (interval time t2) may have different averaging intervals.

Synchronization

For the synchronization of the averaging intervals the internal clock or an external signal via digital input may be used. In case of an external synchronization the interval should be within the given range of one second up to one hour. The synchronization is important for making e.g. the mean value of power quantities on generating and demand side comparable.

Trend

The estimated final value (trend) of mean values is determined by weighted addition of measurements of the past and the present interval. It serves for early detection of a possible exceeding of a given maximum value. This can then be avoided, e.g. by switching off an active load.

History

For mean values of system powers the last 5 interval values may be displayed on the device or read via interface. For configurable quantities the value of the last interval is provided via communication interface.

A6 Meters

| Measured quantity | 1L | 2L | 3Lb | 3Lu | 3Lu.A | 4Lb | 4Lu.O | 4Lu |
|--|---------------------------------------|----|-----|-----|-------|-----|-------|-----|
| Active energy incoming, high tariff | • | • | • | • | • | • | • | • |
| Active energy outgoing, high tariff | • | • | • | • | • | • | • | • |
| Reactive energy inductive, high tariff | • | • | • | • | • | • | • | • |
| Reactive energy capacitive, high tariff | • | • | • | • | • | • | • | • |
| Reactive energy incoming, high tariff | • | • | • | • | • | • | • | • |
| Reactive energy outgoing, high tariff | • | • | • | • | • | • | • | • |
| Active energy incoming, low tariff | • | • | • | • | • | • | • | • |
| Active energy outgoing, low tariff | • | • | • | • | • | • | • | • |
| Reactive energy inductive, low tariff | • | • | • | • | • | • | • | • |
| Reactive energy capacitive, low tariff | • | • | • | • | • | • | • | • |
| Reactive energy incoming, low tariff | • | • | • | • | • | • | • | • |
| Reactive energy outgoing, low tariff | • | • | • | • | • | • | • | • |
| Active energy incoming L1, high tariff | | • | | | | | • | • |
| Active energy incoming L2, high tariff | | • | | | | | • | • |
| Active energy incoming L3, high tariff | | | | | | | • | • |
| Reactive energy incoming L1, high tariff | | • | | | | | • | • |
| Reactive energy incoming L2, high tariff | | • | | | | | • | • |
| Reactive energy incoming L3, high tariff | | | | | | | • | • |
| Active energy incoming L1, low tariff | | • | | | | | • | • |
| Active energy incoming L2, low tariff | | • | | | | | • | • |
| Active energy incoming L3, low tariff | | | | | | | • | • |
| Reactive energy incoming L1, low tariff | | • | | | | | • | • |
| Reactive energy incoming L2, low tariff | | • | | | | | • | • |
| Reactive energy incoming L3, low tariff | | | | | | | • | • |
| Meter I/O 2, high tariff | Independent of measured system | | | | | | | |
| Meter I/O 6, high tariff | | | | | | | | |
| Meter I/O 7, high tariff | | | | | | | | |
| Meter I/O 8, high tariff | | | | | | | | |
| Meter I/O 9, high tariff | | | | | | | | |
| Meter I/O 10, high tariff | | | | | | | | |
| Meter I/O 11, high tariff | | | | | | | | |
| Meter I/O 2, low tariff | | | | | | | | |
| Meter I/O 6, low tariff | | | | | | | | |
| Meter I/O 7, low tariff | | | | | | | | |
| Meter I/O 8, low tariff | | | | | | | | |
| Meter I/O 9, low tariff | | | | | | | | |
| Meter I/O 10, low tariff | | | | | | | | |
| Meter I/O 11, low tariff | | | | | | | | |

Standard meters

The meters for active and reactive energy of the system are always active. The meters for active and reactive energy demand per phase are active only, if the measured system is a multiple phase system with unbalanced load, otherwise they are removed from the above list.

► [Meter reading on the display](#)

I/O meters

The meters of the I/O's are available only if the appropriate I/O's are configured as digital inputs for pulse counting, otherwise they are removed from the above list. No specific unit is shown for this kind of meters, because any energy form may be recorded here.

B Display matrices in DEFAULT mode

B0 Used abbreviations for the measurements

| Name | Description |
|-------------|--|
| U | Voltage system in single, 3- or 4-wire systems |
| U1N | Voltage between phase L1 and neutral |
| U2N | Voltage between phase L2 and neutral |
| U3N | Voltage between phase L3 and neutral |
| U12 | Voltage between phases L1 and L2 |
| U23 | Voltage between phases L2 and L3 |
| U31 | Voltage between phases L3 and L1 |
| UNE | Zero displacement voltage 4-wire systems |
| I | Current system in single, 3- or 4-wire systems |
| I1 | Current phase L1 |
| I2 | Current phase L2 |
| I3 | Current phase L3 |
| IN | Neutral current |
| IB | Current damped, balanced system (bimetal) |
| IB1 | Current damped phase L1 (bimetal) |
| IB2 | Current damped phase L2 (bimetal) |
| IB3 | Current damped phase L3 (bimetal) |
| P | Active power system ($P=P1+P2+P3$) |
| P1 | Active power phase L1 |
| P2 | Active power phase L2 |
| P3 | Active power phase L3 |
| Q | Reactive power system ($Q=Q1+Q2+Q3$) |
| Q1 | Reactive power phase L1 |
| Q2 | Reactive power phase L2 |
| Q3 | Reactive power phase L3 |
| S | Apparent power system |
| S1 | Apparent power phase L1 |
| S2 | Apparent power phase L2 |
| S3 | Apparent power phase L3 |
| F | System frequency |
| PF | Active power factor P/S, system |
| PF1 | Active power factor P1/S1, phase 1 |
| PF2 | Active power factor P2/S2, phase 2 |
| PF3 | Active power factor P3/S3, phase 3 |
| U_MIN_MAX | Minimum and maximum value of U |
| U1N_MIN_MAX | Minimum and maximum value of U1N |
| U2N_MIN_MAX | Minimum and maximum value of U2N |
| U3N_MIN_MAX | Minimum and maximum value of U3N |
| U12_MIN_MAX | Minimum and maximum value of U12 |
| U23_MIN_MAX | Minimum and maximum value of U23 |
| U31_MIN_MAX | Minimum and maximum value of U31 |
| UNE_MIN_MAX | Minimum and maximum value of UNE |
| I_MAX | Maximum value of I |
| I1_MAX | Maximum value of I1 |
| I2_MAX | Maximum value of I2 |
| I3_MAX | Maximum value of I3 |
| IN_MAX | Maximum value of IN |
| IB_MAX | Maximum value of IB |

| Name | Description |
|------------------|--|
| IB1_MAX | Maximum value of IB1 |
| IB2_MAX | Maximum value of IB2 |
| IB3_MAX | Maximum value of IB3 |
| P_MAX | Maximum value of P |
| P1_MAX | Maximum value of P1 |
| P2_MAX | Maximum value of P2 |
| P3_MAX | Maximum value of P3 |
| Q_MAX | Maximum value of Q |
| Q1_MAX | Maximum value of Q1 |
| Q2_MAX | Maximum value of Q2 |
| Q3_MAX | Maximum value of Q3 |
| S_MAX | Maximum value of S |
| S1_MAX | Maximum value of S1 |
| S2_MAX | Maximum value of S2 |
| S3_MAX | Maximum value of S3 |
| F_MIN_MAX | Minimum and maximum value of F |
| PF_MIN | Graphic: Minimum active power factor (PF) in all 4 quadrants |
| UR1 | Positive sequence voltage |
| UR2 | Negative sequence voltage |
| U0 | Zero sequence voltage |
| IR1 | Positive sequence current |
| IR2 | Negative sequence current |
| I0 | Zero sequence current |
| UNB_UR2_UR1 | Unbalance factor voltage UR2/UR1 |
| UNB_IR2_IR1 | Unbalance factor current IR2/IR1 |
| Px_TRIANGLE | Graphic of the power triangle consisting of: <ul style="list-style-type: none"> • Active, reactive and apparent power • Distortion reactive power and reactive power of the fundamental • $\cos(\varphi)$ of fundamental system • Active power factor |
| UNB_UR2_UR1_MAX | Max. unbalance factor voltage UR2/UR1 |
| UNB_IR2_IR1_MAX | Max. unbalance factor current IR2/IR1 |
| PFG_MIN | Graphic: Minimum $\cos(\varphi)$ fundamental (PFG) in all 4 quadrants |
| MT_PIN | Graphic mean-value P incoming: Trend, last 5 interval values, minimum und maximum |
| MT_POUT | Graphic mean-value P outgoing: Trend, last 5 interval values, minimum und maximum |
| MT_QIN | Graphic mean-value Q incoming: Trend, last 5 interval values, minimum und maximum |
| MT_QOUT | Graphic mean-value Q outgoing: Trend, last 5 interval values, minimum und maximum |
| MT_QIND | Graphic mean-value Q inductive: Trend, last 5 interval values, minimum und maximum |
| MT_QCAP | Graphic mean-value Q capacitive: Trend, last 5 interval values, minimum und maximum |
| MT_S | Graphic mean-value S: Trend, last 5 interval values, minimum und maximum |
| Σ PIN_HT | Meter P incoming high tariff |
| Σ POUT_HT | Meter P outgoing high tariff |
| Σ QIND_HT | Meter Q inductive high tariff |
| Σ QCAP_HT | Meter Q capacitive high tariff |
| Σ QIN_HT | Meter Q incoming high tariff |
| Σ QOUT_HT | Meter Q outgoing high tariff |
| Σ PIN_LT | Meter P incoming low tariff |
| Σ POUT_LT | Meter P outgoing low tariff |
| Σ QIND_LT | Meter Q inductive low tariff |
| Σ QCAP_LT | Meter Q capacitive low tariff |
| Σ QIN_LT | Meter Q incoming low tariff |
| Σ QOUT_LT | Meter Q outgoing low tariff |
| Σ P1IN_HT | Meter P1 incoming high tariff |

| Name | Description |
|------------|---|
| ΣP2IN_HT | Meter P2 incoming high tariff |
| ΣP3IN_HT | Meter P3 incoming high tariff |
| ΣQ1IN_HT | Meter Q1 incoming high tariff |
| ΣQ2IN_HT | Meter Q2 incoming high tariff |
| ΣQ3IN_HT | Meter Q3 incoming high tariff |
| ΣP1IN_LT | Meter P1 incoming low tariff |
| ΣP2IN_LT | Meter P2 incoming low tariff |
| ΣP3IN_LT | Meter P3 incoming low tariff |
| ΣQ1IN_LT | Meter Q1 incoming low tariff |
| ΣQ2IN_LT | Meter Q2 incoming low tariff |
| ΣQ3IN_LT | Meter Q3 incoming low tariff |
| HO_UX | Graphic: Odd harmonics 3rd up to 49th + Total Harmonic Distortion of all voltages |
| HO_IX | Graphic: Odd harmonics 3rd up to 49th + Total Demand Distortion of all currents |
| HE_UX | Graphic: Even harmonics 2nd up to 50th + Total Harmonic Distortion of all voltages |
| HE_IX | Graphic: Even harmonics 2nd up to 50th + Total Demand Distortion of all currents |
| HO_UX_MAX | Graphic: Maximum values odd harmonics 3rd up to 49th + Total Harmonic Distortion of all voltages |
| HO_IX_MAX | Graphic: Maximum values odd harmonics 3rd up to 49th + Total Demand Distortion of all currents |
| HE_UX_MAX | Graphic: Maximum values even harmonics 2nd up to 50th + Total Harmonic Distortion of all voltages |
| HE_IX_MAX | Graphic: Maximum values even harmonics 2nd up to 50th + Total Demand Distortion of all currents |
| ALARM | Alarm list: State of all alarms and the associated follow-up operations |
| LOGGER | State information data logger: Memory usage and last events of all logger parts |
| OPR_CNTR | Operating hour counter APLUS |
| OPR_CNTR1 | Resettable operating hour counter 1 |
| OPR_CNTR2 | Resettable operating hour counter 2 |
| OPR_CNTR3 | Resettable operating hour counter 3 |
| RTC_LOCAL | Local time in seconds since January 1st 1970 |
| DEV_TAG | Device TAG |
| MTR_TARIFF | Present meter tariff |
| DEV_ID | Serial number of device |
| NLB_NO | NLB number (number of special device version) |

B1 Display matrix single phase system

| | | | | | | | |
|--|--|---|---|-----------|-----------|-----------|-----------|
| U I P F | U_MIN_MAX I_MAX P_MAX F_MIN_MAX | | | | | | |
| P Q S PF | P_MAX Q_MAX S_MAX | | | | | | |
| ΣPIN_HT ΣPIN_LT ΣQIN_HT ΣQIN_LT | ΣQIND_HT ΣQIND_LT ΣQCAP_HT ΣQCAP_LT | ΣPOUT_HT ΣPOUT_LT ΣQOUT_HT ΣQOUT_LT | | | | | |
| MT_PIN | MT_POUT | MT_QIN | MT_QOUT | MT_QIND | MT_QCAP | MT_S | |
| HO_UX | HO_IX | HE_UX | HE_IX | HO_UX_MAX | HO_IX_MAX | HE_UX_MAX | HE_IX_MAX |
| VECTOR | P_TRIANGLE | PF_MIN | PFG_MIN | | | | |
| ALARM | LOGGER | OPR_CNTR OPR_CNTR1 OPR_CNTR2 OPR_CNTR3 | DEV_TAG MTR_TARIFF DEV_ID NLB_NO | | | | |

B2 Display matrix Split-phase (two-phase) systems

| | | | | | | | |
|--|--|---|---|-----------|-----------|-----------|-----------|
| U1N U2N U F | U1N_MIN_MAX U2N_MIN_MAX U_MIN_MAX F_MIN_MAX | | | | | | |
| I1 TDD_I1 IB1 IB1_MAX | I2 TDD_I2 IB2 IB2_MAX | I1_MAX I2_MAX TDD_I1_MAX TDD_I2_MAX | | | | | |
| P Q S PF | P1 P2 Q1 Q2 | P_MAX Q_MAX S_MAX | P1_MAX P2_MAX Q1_MAX Q2_MAX | | | | |
| ΣPIN_HT ΣPIN_LT ΣQIN_HT ΣQIN_LT | ΣQIND_HT ΣQIND_LT ΣQCAP_HT ΣQCAP_LT | ΣPOUT_HT ΣPOUT_LT ΣQOUT_HT ΣQOUT_LT | | | | | |
| MT_PIN | MT_POUT | MT_QIN | MT_QOUT | MT_QIND | MT_QCAP | MT_S | |
| HO_UX | HO_IX | HE_UX | HE_IX | HO_UX_MAX | HO_IX_MAX | HE_UX_MAX | HE_IX_MAX |
| VECTOR | P-TRIANGLE | P1_TRIANGLE | P2_TRIANGLE | PF_MIN | PFG_MIN | | |
| ALARM | LOGGER | OPR_CNTR OPR_CNTR1 OPR_CNTR2 OPR_CNTR3 | DEV_TAG MTR_TARIFF DEV_ID NLB_NO | | | | |

B3 Display matrix 3-wire system, balanced load

| | | | | | | | |
|--|--|--|---|-----------|-----------|-----------|-----------|
| U12 U23 U31 F | UR1 UR2 | U12_MIN_MAX U23_MIN_MAX U31_MIN_MAX F_MIN_MAX | | | | | |
| I IB I_MAX IB_MAX | | | | | | | |
| P Q S PF | P_MAX Q_MAX S_MAX | | | | | | |
| Σ PIN_HT Σ PIN_LT Σ QIN_HT Σ QIN_LT | Σ QIND_HT Σ QIND_LT Σ QCAP_HT Σ QCAP_LT | Σ POUT_HT Σ POUT_LT Σ QOUT_HT Σ QOUT_LT | | | | | |
| MT_PIN | MT_POUT | MT_QIN | MT_QOUT | MT_QIND | MT_QCAP | MT_S | |
| HO_UX | HO_IX | HE_UX | HE_IX | HO_UX_MAX | HO_IX_MAX | HE_UX_MAX | HE_IX_MAX |
| VECTOR | P_TRIANGLE | PF_MIN | PFG_MIN | | | | |
| ALARM | LOGGER | OPR_CNTR OPR_CNTR1 OPR_CNTR2 OPR_CNTR3 | DEV_TAG MTR_TARIFF DEV_ID NLB_NO | | | | |

B4 Display matrix 3-wire systems, unbalanced load

| | | | | | | | |
|--|--|--|---|-------------------------------|-----------|-----------|-----------|
| U12 U23 U31 F | UR1 UR2 UNB_UR2_UR1 | U12_MIN_MAX U23_MIN_MAX U31_MIN_MAX F_MIN_MAX | | | | | |
| I1 I2 I3 | IB1 IB2 IB3 | IR1 IR2 UNB_IR2_IR1 | I1_MAX I2_MAX I3_MAX | IB1_MAX IB2_MAX IB3_MAX | | | |
| P Q S PF | P_MAX Q_MAX S_MAX | | | | | | |
| Σ PIN_HT Σ PIN_LT Σ QIN_HT Σ QIN_LT | Σ QIND_HT Σ QIND_LT Σ QCAP_HT Σ QCAP_LT | Σ POUT_HT Σ POUT_LT Σ QOUT_HT Σ QOUT_LT | | | | | |
| MT_PIN | MT_POUT | MT_QIN | MT_QOUT | MT_QIND | MT_QCAP | MT_S | |
| HO_UX | HO_IX | HE_UX | HE_IX | HO_UX_MAX | HO_IX_MAX | HE_UX_MAX | HE_IX_MAX |
| VECTOR | P_TRIANGLE | PF_MIN | PFG_MIN | | | | |
| ALARM | LOGGER | OPR_CNTR OPR_CNTR1 OPR_CNTR2 OPR_CNTR3 | DEV_TAG MTR_TARIFF DEV_ID NLB_NO | | | | |

B5 Display matrix 3-wire systems, unbalanced load, Aron

| | | | | | | | |
|--|--|--|---|-----------|-----------|-----------|-----------|
| U12 U23 U31 F | UR1 UR2 UNB_UR2_UR1 | U12_MIN_MAX U23_MIN_MAX U31_MIN_MAX F_MIN_MAX | | | | | |
| I1 I2 I3 | IB1 IB2 IB3 | I1_MAX I2_MAX I3_MAX | IB1_MAX IB2_MAX IB3_MAX | | | | |
| P Q S PF | P_MAX Q_MAX S_MAX | | | | | | |
| Σ PIN_HT Σ PIN_LT Σ QIN_HT Σ QIN_LT | Σ QIND_HT Σ QIND_LT Σ QCAP_HT Σ QCAP_LT | Σ POUT_HT Σ POUT_LT Σ QOUT_HT Σ QOUT_LT | | | | | |
| MT_PIN | MT_POUT | MT_QIN | MT_QOUT | MT_QIND | MT_QCAP | MT_S | |
| HO_UX | HO_IX | HE_UX | HE_IX | HO_UX_MAX | HO_IX_MAX | HE_UX_MAX | HE_IX_MAX |
| VECTOR | P_TRIANGLE | PF_MIN | PFG_MIN | | | | |
| ALARM | LOGGER | OPR_CNTR OPR_CNTR1 OPR_CNTR2 OPR_CNTR3 | DEV_TAG MTR_TARIFF DEV_ID NLB_NO | | | | |

B6 Display matrix 4-wire system, balanced load

| | | | | | | | |
|--|--|--|---|-----------|-----------|-----------|-----------|
| U I P F | U_MIN_MAX I_MAX P_MAX F_MIN_MAX | | | | | | |
| P Q S PF | | | | | | | |
| Σ PIN_HT Σ PIN_LT Σ QIN_HT Σ QIN_LT | Σ QIND_HT Σ QIND_LT Σ QCAP_HT Σ QCAP_LT | Σ POUT_HT Σ POUT_LT Σ QOUT_HT Σ QOUT_LT | | | | | |
| MT_PIN | MT_POUT | MT_QIN | MT_QOUT | MT_QIND | MT_QCAP | MT_S | |
| HO_UX | HO_IX | HE_UX | HE_IX | HO_UX_MAX | HO_IX_MAX | HE_UX_MAX | HE_IX_MAX |
| VECTOR | P_TRIANGLE | PF_MIN | PFG_MIN | | | | |
| ALARM | LOGGER | OPR_CNTR OPR_CNTR1 OPR_CNTR2 OPR_CNTR3 | DEV_TAG MTR_TARIFF DEV_ID NLB_NO | | | | |

B7 Display matrix 4-wire systems, unbalanced load

| | | | | | | | |
|--|--|--|---|---|---|---|-------------------------|
| U1N U2N U3N F | U12 U23 U31 F | UR1 UR2 U0 UNB_UR2_UR1 | U1N_MIN_MAX U2N_MIN_MAX U3N_MIN_MAX F_MIN_MAX | U12_MIN_MAX U23_MIN_MAX U31_MIN_MAX F_MIN_MAX | | | |
| I1 I2 I3 IN | IB1 IB2 IB3 | IR1 IR2 I0 UNB_IR2_IR1 | I1_MAX I2_MAX I3_MAX IN_MAX | IB1_MAX IB2_MAX IB3_MAX | | | |
| P Q S PF | P1 P2 P3 P | Q1 Q2 Q3 Q | S1 S2 S3 S | P1_MAX P2_MAX P3_MAX P_MAX | Q1_MAX Q2_MAX Q3_MAX Q_MAX | S1_MAX S2_MAX S3_MAX S_MAX | P_MAX Q_MAX S_MAX |
| Σ PIN_HT Σ PIN_LT Σ QIN_HT Σ QIN_LT | Σ QIND_HT Σ QIND_LT Σ QCAP_HT Σ QCAP_LT | Σ POUT_HT Σ POUT_LT Σ QOUT_HT Σ QOUT_LT | Σ P1IN_HT Σ P2IN_HT Σ P3IN_HT Σ PIN_HT | Σ P1IN_LT Σ P2IN_LT Σ P3IN_LT Σ PIN_LT | Σ Q1IN_HT Σ Q2IN_HT Σ Q3IN_HT Σ QIN_HT | Σ Q1IN_LT Σ Q2IN_LT Σ Q3IN_LT Σ QIN_LT | |
| MT_PIN | MT_POUT | MT_QIN | MT_QOUT | MT_QIND | MT_QCAP | MT_S | |
| HO_UX | HO_IX | HE_UX | HE_IX | HO_UX_MAX | HO_IX_MAX | HE_UX_MAX | HE_IX_MAX |
| VECTOR | P_TRIANGLE | P1_TRIANGLE | P2_TRIANGLE | P3_TRIANGLE | PF_MIN | PFG_MIN | |
| ALARM | LOGGER | OPR_CNTR OPR_CNTR1 OPR_CNTR2 OPR_CNTR3 | DEV_TAG MTR_TARIFF DEV_ID NLB_NO | | | | |

B8 Display matrix 4-wire system, unbalanced load, Open-Y

| | | | | | | | |
|--|--|--|---|---|---|---|-------------------------|
| U1N U2N U3N F | U12 U23 U31 F | U1N_MIN_MAX U2N_MIN_MAX U3N_MIN_MAX F_MIN_MAX | U12_MIN_MAX U23_MIN_MAX U31_MIN_MAX F_MIN_MAX | | | | |
| I1 I2 I3 IN | IB1 IB2 IB3 | IR1 IR2 I0 UNB_IR2_IR1 | I1_MAX I2_MAX I3_MAX IN_MAX | IB1_MAX IB2_MAX IB3_MAX | | | |
| P Q S PF | P1 P2 P3 P | Q1 Q2 Q3 Q | S1 S2 S3 S | P1_MAX P2_MAX P3_MAX P_MAX | Q1_MAX Q2_MAX Q3_MAX Q_MAX | S1_MAX S2_MAX S3_MAX S_MAX | P_MAX Q_MAX S_MAX |
| Σ PIN_HT Σ PIN_LT Σ QIN_HT Σ QIN_LT | Σ QIND_HT Σ QIND_LT Σ QCAP_HT Σ QCAP_LT | Σ POUT_HT Σ POUT_LT Σ QOUT_HT Σ QOUT_LT | Σ P1IN_HT Σ P2IN_HT Σ P3IN_HT Σ PIN_HT | Σ P1IN_LT Σ P2IN_LT Σ P3IN_LT Σ PIN_LT | Σ Q1IN_HT Σ Q2IN_HT Σ Q3IN_HT Σ QIN_HT | Σ Q1IN_LT Σ Q2IN_LT Σ Q3IN_LT Σ QIN_LT | |
| MT_PIN | MT_POUT | MT_QIN | MT_QOUT | MT_QIND | MT_QCAP | MT_S | |
| HO_UX | HO_IX | HE_UX | HE_IX | HO_UX_MAX | HO_IX_MAX | HE_UX_MAX | HE_IX_MAX |
| VECTOR | P_TRIANGLE | P1_TRIANGLE | P2_TRIANGLE | P3_TRIANGLE | PF_MIN | PFG_MIN | |
| ALARM | LOGGER | OPR_CNTR OPR_CNTR1 OPR_CNTR2 OPR_CNTR3 | DEV_TAG MTR_TARIFF DEV_ID NLB_NO | | | | |

C Declaration of conformity

C1 CE conformity



EG - KONFORMITÄTSERKLÄRUNG
EC DECLARATION OF CONFORMITY



Dokument-Nr./ Document.No.: **APLUS_CE-konf.DOC**

Hersteller/ Manufacturer: **Camille Bauer AG**
Switzerland

Anschrift / Address: **Aargauerstrasse 7**
CH-5610 Wohlen

Produktbezeichnung/ Product name: **Multifunktionales Leistungsmessgerät mit Netzanalyse**
Multifunctional Power Monitor with System Analysis

Typ / Type: **APLUS**

Das bezeichnete Produkt stimmt mit den Vorschriften folgender Europäischer Richtlinien überein, nachgewiesen durch die Einhaltung folgender Normen:

The above mentioned product has been manufactured according to the regulations of the following European directives proven through compliance with the following standards:

| Nr. / No. | Richtlinie / Directive |
|-------------|---|
| 2004/108/EG | Elektromagnetische Verträglichkeit - EMV-Richtlinie |
| 2004/108/EC | Electromagnetic compatibility - EMC directive |

| EMV / EMC | Fachgrundnorm / Generic Standard | Messverfahren / Measurement methods |
|---------------------------|----------------------------------|--|
| Störaussendung / Emission | EN 61000-6-4 : 2007 | EN 55011 : 2007+A2:2007 |
| Störfestigkeit / Immunity | EN 61000-6-2 : 2005 | IEC 61000-4-2: 1995+A1:1998+A2:2001 IEC 61000-4-3: 2006+A1:2007 IEC 61000-4-4: 2004 IEC 61000-4-5: 2005 IEC 61000-4-6: 2008 IEC 61000-4-8: 1993+A1:2000 IEC 61000-4-11: 2004 |

| Nr. / No. | Richtlinie / Directive |
|------------|---|
| 2006/95/EG | Elektrische Betriebsmittel zur Verwendung innerhalb bestimmter Spannungsgrenzen – Niederspannungsrichtlinie – CE-Kennzeichnung : 95 |
| 2006/95/EC | Electrical equipment for use within certain voltage limits – Low Voltage Directive – Attachment of CE marking : 95 |

| EN/Norm/Standard | IEC/Norm/Standard |
|------------------|-------------------|
| EN 61010-1: 2010 | IEC 61010-1: 2010 |

Ort, Datum / Place, date: **Wohlen, 01.Feb.2013**

Unterschrift / signature:

M. Ulrich
Leiter Technik / Head of engineering

J. Brem
Qualitätsmanager / Quality manager

C2 FCC statement

The following statement applies to the products covered in this manual, unless otherwise specified herein. The statement for other products will appear in the accompanying documentation.

NOTE: This equipment has been tested and found to comply with the limits for a Class A digital device, pursuant to Part 15 of the FCC Rules and meets all requirements of the Canadian Interference-Causing Equipment Standard ICES-003 for digital apparatus. These limits are designed to provide reasonable protection against harmful interference in a residential installation. This equipment generates, uses, and can radiate radio frequency energy and, if not installed and used in accordance with the instructions, may cause harmful interference to radio communications. However, there is no guarantee that interference will not occur in a particular installation. If this equipment does cause harmful interference to radio or television reception, which can be determined by turning the equipment off and on, the user is encouraged to try to correct the interference by one or more of the following measures:

- Reorient or relocate the receiving antenna.
- Increase the separation between the equipment and receiver.
- Connect the equipment into an outlet on a circuit different from that to which the receiver is connected.
- Consult the dealer or an experienced radio/T.V. technician for help.

Camille Bauer AG is not responsible for any radio television interference caused by unauthorized modifications of this equipment or the substitution or attachment of connecting cables and equipment other than those specified by Camille Bauer AG. The correction of interference caused by such unauthorized modification, substitution or attachment will be the responsibility of the user.

INDEX

A

| | |
|--------------------------------|----|
| Acknowledgment of alarms | 39 |
| Alarm handling..... | 39 |
| Alarming | |
| concept | 8 |
| reset..... | 8 |
| Auto-scaling | 7 |

C

| | |
|---------------------|----|
| Commissioning | 27 |
| Configuration | |
| menu..... | 41 |

D

| | |
|----------------------------------|----|
| Data logger | 42 |
| activation..... | 42 |
| analysis..... | 43 |
| Declaration of conformity | 67 |
| Device overview..... | 6 |
| Dimensional drawings | |
| with display | 50 |
| without display | 50 |
| Display matrices..... | 60 |
| Display modes | |
| DEFAULT | 38 |
| LOOP..... | 38 |
| USER..... | 38 |
| Driving a counter mechanism..... | 24 |

E

| | |
|------------------------------|----|
| Electrical connections | |
| analog outputs | 25 |
| Aron connection | 19 |
| cross sections | 16 |
| digital input..... | 23 |
| digital output..... | 24 |
| inputs | 17 |
| Modbus interface..... | 25 |
| Open-Y | 20 |
| power supply..... | 22 |
| Profibus DP | 26 |
| relays | 22 |
| Rogowski current inputs..... | 21 |
| split phase..... | 21 |

| | |
|----------------------------|----|
| Ethernet | 30 |
| LEDs | 30 |
| Network installation | 31 |

F

| | |
|----------------|----|
| Firewall | 33 |
|----------------|----|

I

| | |
|--------------------------|----|
| Installation check | 29 |
|--------------------------|----|

L

| | |
|----------------------------|----|
| Limit values | 11 |
| dynamical monitoring | 7 |
| Logic components | |
| AND | 10 |
| NAND..... | 10 |
| NOR..... | 10 |
| OR | 10 |
| XNOR..... | 10 |
| XOR | 10 |

M

| | |
|--------------------------------|----|
| Measured quantities..... | 51 |
| Basic measurements..... | 51 |
| earth fault monitoring..... | 53 |
| harmonic analysis | 54 |
| mean values and trend..... | 58 |
| meters | 59 |
| power factors..... | 52 |
| reactive power..... | 56 |
| system imbalance | 55 |
| zero displacement voltage..... | 53 |
| Measurement | |
| continuous..... | 7 |
| Measurements | |
| reset..... | 40 |
| Mechanical mounting | 14 |
| Menu..... | 41 |
| Meter | |
| reset..... | 40 |
| Metering..... | 7 |
| Modbus image | 13 |
| Modes of operation | 7 |
| Monitoring | 8 |

Mounting 14

N

NTP 33

O

operating elements 36

operating hour counters 11

Operating modes 37

P

Profibus DP

 installation 34

 LED's 26

R

Resetting measurements 40

S

Scope of supply 5

SD-Card 42

 access 43

 changing 42

 LED 42

Security notes 6

Service and maintenance 44

Software

 CB-Analyzer 43

 CB-Manager 27

 online / offline 29

 operating 28

 security system 35

 Simulation of I/O's 29

Symmetrical components 55

T

TCP ports 33

Technical data 45

Time and date 41

Time synchronization 33

U

UTC 41

Z

Zero suppression 46